



[www.hy-lok.com](http://www.hy-lok.com)

Catalog No. H-240FF  
Dec. 2015

# 37° Flared Tube Fittings for SAE J514 & ISO8434 Part2

---

## Flareless Tube Fitting for SAE J514



**HY-LOK CORPORATION**

© 2002, 2015 HY-LOK CORPORATION All rights reserved



## 37° Flared Tube Fittings

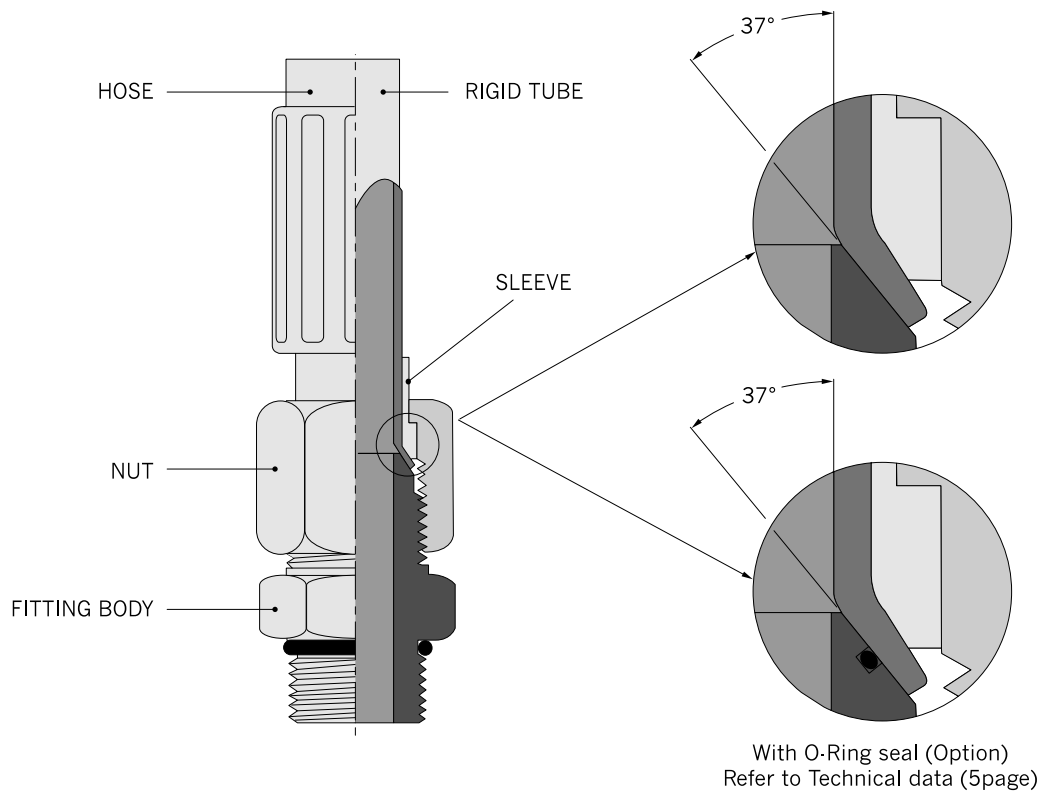

*This type of assembly ensures very high dependability.*

*The assembly is achieved by connecting the two parts together by means of a nut and a sleeve.*

### Main Characteristics

The assembly performs extremely well even under severe vibrations, pressure bursts, and thermal shocks.

On tightening, the sleeve ensures tube alignment with fitting axis, reduces mechanical strain on tube and decreases vibrations.

Fitting can be equally coupled to metric or inch-tubes.

The tube doesn't undergo distortion, remains constant and fluid pressure losses are negligible.

The system efficiency remains equally guaranteed after several disassemblies and assembly operations and individual replacement of any component.

### Material and Surface Protection

Fittings are normally made of steel and obtained from controlled bar-stock machining (straight fittings, nuts) or by hot or cold forming (shaped fittings, sleeves). Alternative materials such as brass, aluminium, stainless steel available upon request.

All carbon steel fittings but those to be brazed or welded-on tubes, are yellow zinc plated to a Min. thickness of 0.008 mm to comply with ASTM-B-117, UNI 5687 hot salt spray test method.

All threads are shock protected with plastic caps or plugs.

### Seals

All fittings requiring seals are supplied with O-Ring seals and washers.

## Flaring Operation

Tube flaring is carried out in two different ways ; single wall flare on thick wall tubes and double wall flare on thin wall tubes to reinforce same. Refer to table I and II for recommended values.

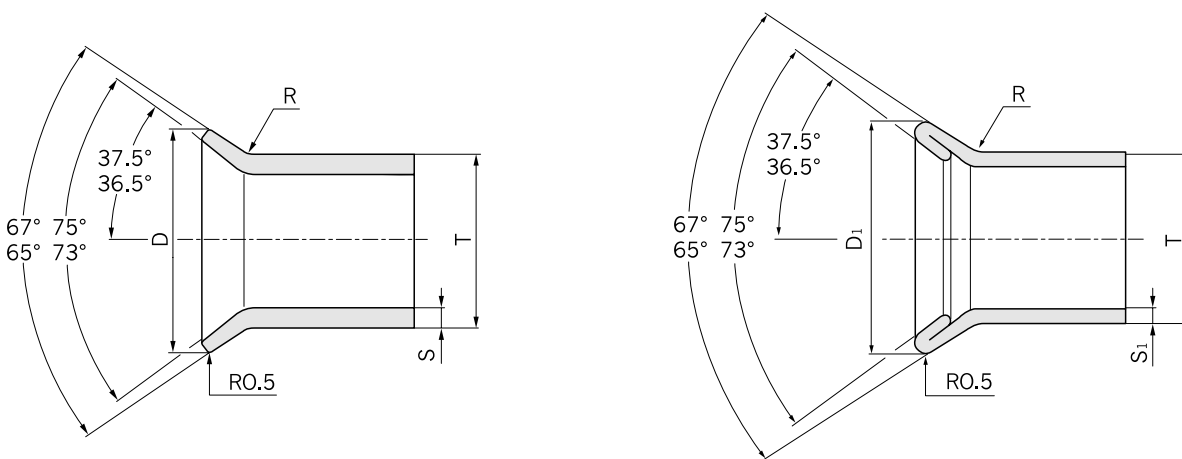

Table I - Metric Tubes.

T Tube O.D	D		S	D <sub>1</sub>		S <sub>1</sub>	R
	Max.	Min.		Max.	Min.		
6	9.2	8.4	1.5	9.2	8.4	0.88	0.8
8	10.8	10.1	1.5	10.8	10.1	0.88	0.8
10	12.5	12.0	1.5	12.5	12.0	1.20	1.0
12	16.7	16.0	2.0	16.7	16.0	1.20	1.5
14	19.5	18.8	2.0	19.5	18.8	1.20	1.5
15	20.0	19.4	2.0	20.0	19.4	1.20	1.5
16	20.0	19.4	2.5	20.0	19.4	1.20	1.5
18	24.0	23.5	2.5	24.0	23.5	1.20	2.0
20	24.5	24.0	2.5	24.5	24.0	1.50	2.0
22	27.2	26.2	3.0	27.2	26.2	1.50	2.0
25	30.2	29.5	3.0	30.2	29.5	1.50	2.3
30	38.0	37.4	3.0	38.0	37.4	1.50	2.3
32	38.3	37.6	3.0	38.3	37.6	1.50	2.3
38	44.5	43.5	4.0	44.5	43.5	1.50	2.8

Table I - Inch Tubes

T Tube O.D	D		S	D <sub>1</sub>		S <sub>1</sub>	R
	Max.	Min.		Max.	Min.		
1/4	9.1	8.6	1.6	9.1	8.6	0.8	0.8
5/16	10.9	10.2	1.6	10.9	10.2	0.8	0.8
3/8	12.4	11.6	1.6	12.4	11.6	1.2	1.0
1/2	16.7	16.0	2.1	16.7	16.0	1.2	1.5
5/8	20.0	19.3	2.4	20.0	19.3	1.2	1.5
3/4	24.1	23.3	2.7	24.1	23.3	1.2	2.0
7/8	27.1	26.4	2.7	27.1	26.4	1.6	2.0
1"	30.4	29.7	3.0	30.4	29.7	1.6	2.2
1" 1/4	38.3	37.5	3.0	38.3	37.5	1.6	2.2
1" 1/2	44.4	43.1	4.0	44.4	43.1	1.6	2.7

## 37° Flared Tube Fittings

### Condition For A Correct Flaring

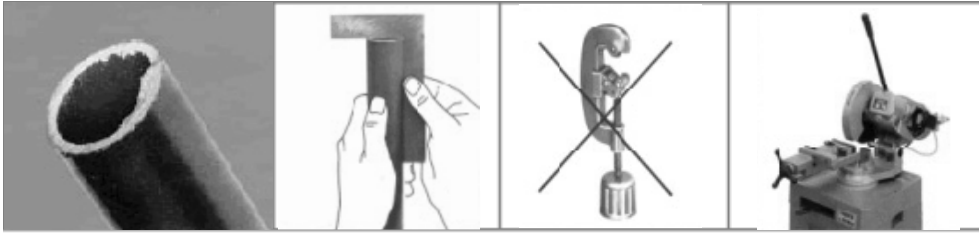

#### 1.0 Sawing process

- 1.1 Saw the tube at light angle. An angular offset of 0.5° in relation to the tube axis is permissible.
- 1.2 Do not use a tube cutter because this would cause formation of considerable burrs and an angular cut. Use sawing machine or device instead.

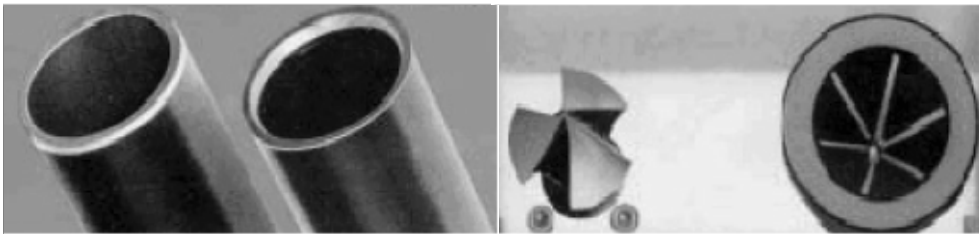

#### 2.0 Deburring process

- 2.1 After cleaning the tube, lightly deburr the tube ends at the inside and outside edge.

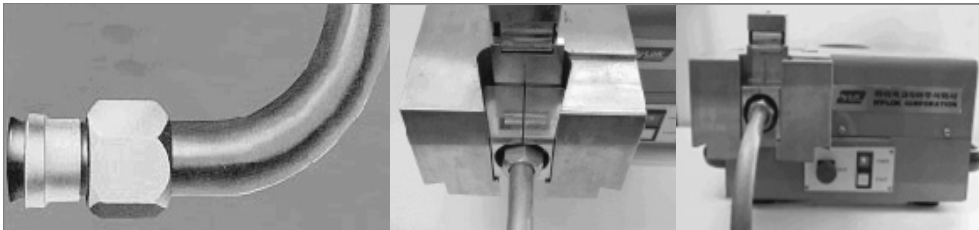

#### 3.0 Flaring process

- 3.1 Set the pressure in accordance with table.
- 3.2 Oil the flaring cone.
- 3.3 Insert the clamping grips corresponding to each outside diameter of the tube to the flaring device.
- 3.4 Slide the nut and sleeve onto the tube.
- 3.5 Insert the tube through the clamping grips up to the stopper and press against it.
- 3.6 Start with the flaring process.
- 3.7 Remove the flared tube including the clamping grips from the flaring device.

### Attention

The flare collar has to be square and concentric to the tube as well as to the flared body of 37°

Unequal flarings point to either defect tools or to manual operating mistakes.

The inside cone of the tube has to be clean, in case the surface is faulty, it has to be polished with a polishing mandrel.

### Assembly Instructions.

On the table below are shown the basic dimensions to calculate the overall length of tube assemblies, the actual dimension of fittings when assembled, the recommended assembly torques and working pressures.

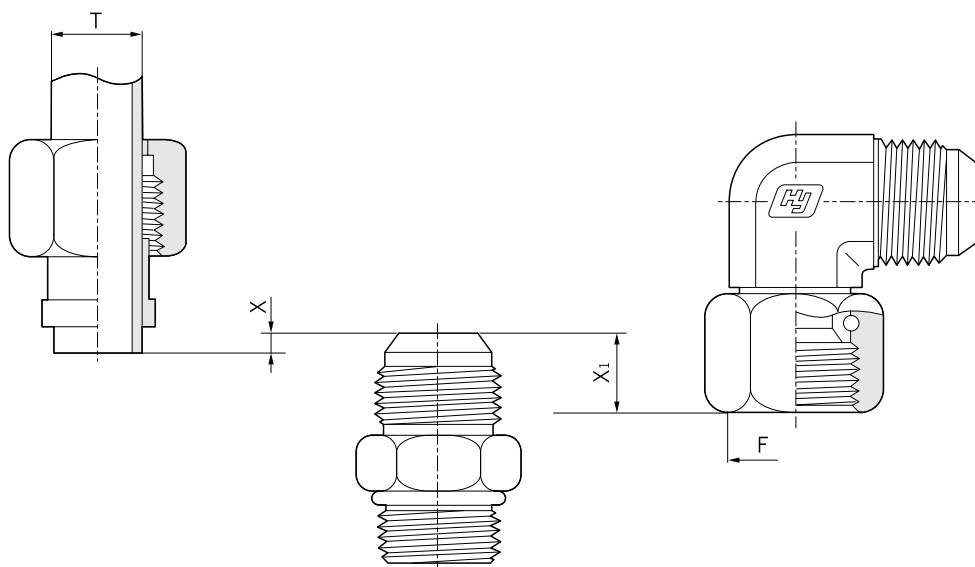

### Technical Data

T Tube O.D		F Thread	X	X <sub>1</sub>	Assembly Torque		Standard Working Pressures				Working Pressures	
mm	in.	JIC	mm	mm	Nm -0%, +10%		SAE J 514		ISO 8434-2		SAE J514 with o-ring	
					Carbon Steel	Stainless Steel	psi	bar	Mpa	bar	psi	bar
6	1/4	7/16 - 20	2.0	10.0	18	30	5,000	350	35.0	350	8,700	600
8	5/16	1/2 - 20	2.0	11.0	20	40	5,000	350	35.0	350	8,700	600
10	3/8	9/16 - 18	2.0	11.5	30	60	5,000	350	35.0	350	8,700	600
12	1/2	3/4 - 16	3.0	13.0	57	115	4,500	315	31.0	310	7,250	500
14	-											
15	-	7/8 - 14	3.5	15.5	81	145	3,500	240	24.0	240	7,250	500
16	5/8											
18	3/4	1" 1/16 - 12	3.5	17.5	114	180	3,500	240	24.0	240	7,250	500
20	-	1" 1/16 - 12	3.5	17.5	114	180	3,500	240	24.0	240	7,250	500
22	7/8	1" 3/16 - 12	3.5	18.0	136	225	3,000	210	21.0	210	7,250	500
25	1"	1" 5/16 - 12	3.5	18.5	160	225	3,000	210	21.0	210	6,090	420
30	-	1" 5/8 - 12	5.0	20.5	228	295	2,500	170	17.0	170	6,090	420
32	1" 1/4	1" 5/8 - 12	5.0	20.5	228	295	2,500	170	17.0	170	6,090	420
38	1" 1/2	1" 7/8 - 12	5.0	23.0	265	345	2,000	140	10.5	105	6,090	420

**Note :** 1. Material : AISI 316 and Carbon steel  
 2. 1 bar = 0.1 Mpa = 14.5 psi

# 37° Flared Tube Fittings

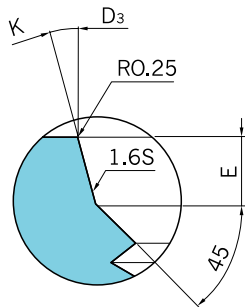
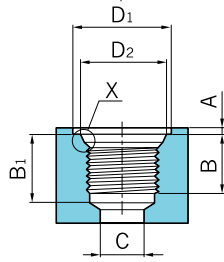
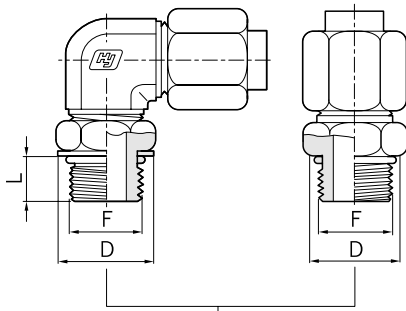

Detail X

## Unified Straight Thread Ports (ISO 11926)

O-Ring sealing.

D3 diameter must be concentric to thread.  
Max. allowed error 0.13 mm.

Spot-faced surface must be square to thread in port.

Machining operation such as A and D1 is not required when port surface complies with requirements.

## Table of Dimensions

F (Thread size) Division	7/16-20 UNF	1/2-20 UNF	9/16-18 UNF	3/4-16 UNF	7/8-14 UNF	1 1/16-12 UN	1 3/16-12 UN	1 5/16-12 UN	1 5/8-12 UN	1 7/8-12 UN
OD Nom.	11.1	12.7	14.2	19.0	22.2	26.9	30.1	33.3	41.2	47.6
ID Min.	9.8	11.5	12.9	17.5	20.4	24.8	27.9	31.3	39.1	45.5
A Max.	1.6	1.6	1.6	2.4	2.4	2.4	2.4	3.2	3.2	3.2
B Min.	11.5	11.5	12.7	14.3	16.7	19.0	19.0	19.0	19.0	19.0
B <sub>1</sub> Min.	14.0	14.0	15.5	17.5	20.0	23.0	23.0	23.0	23.0	23.0
C Min.	4.4	6.0	7.5	10.0	12.5	16.0	18.0	21.0	27.0	33.0
D	16.5	18.3	20.2	25.7	29.3	36.7	40.4	44.5	55.0	62.3
D <sub>1</sub> Min.	21.0	23.0	25.0	30.0	34.0	41.0	45.0	49.0	58.0	65.0
D <sub>2</sub> Min.	15.0	16.0	18.0	22.0	26.0	32.0	35.0	38.0	48.0	54.0
D <sub>3</sub> <sup>+0.1 0</sup>	12.4	14.0	15.6	20.6	23.9	29.2	32.3	35.5	43.5	49.8
E <sup>+0.4 0</sup>	2.4	2.4	2.5	2.5	2.5	3.3	3.3	3.3	3.3	3.3
K ±1	12°	12°	12°	15°	15°	15°	15°	15°	15°	15°
L	9.5	9.5	10.5	12.0	13.5	15.5	15.5	15.5	15.5	15.5
*O-Ring	8.92 x t1.83	10.52 x t1.83	11.89 x t1.98	16.36 x t2.21	19.18 x t2.46	23.47 x t2.95	26.59 x t2.95	29.74 x t2.95	37.47 x t3.0	43.69 x t3.0
Assembly torque (Nm)	1)	23	28	34	60	115	140	170	210	290
	2)	18	28	34	55	80	100	125	150	290

Note : 1) Non-adjustable end.  
2) Adjustable end.

Standard O-Rings : NBR SHORE-A 85 ±5 (Max. temp. rang. -30°C +120°C). Additional compounds are available on request. For special applications, please contact our technical department.

## Metric Parallel Thread Ports (ISO 6149)

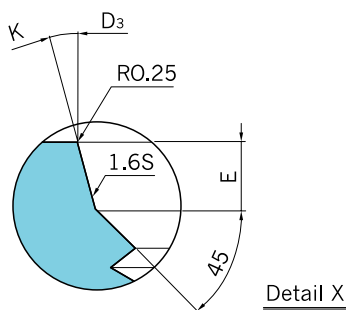
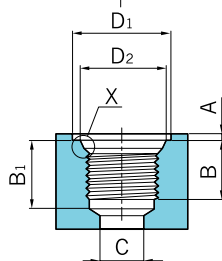
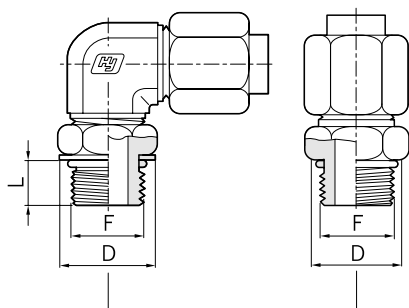

O-Ring sealing.

D3 diameter must be concentric to thread.  
Max. allowed error 0.13 mm.

Spot-faced surface must be square to thread in port.

Machining operation such as A and D1 is not required when port surface complies with requirements.

**Table of Dimensions**

F (Thread size) Division	M10 x 1.0	M12 x 1.5	M14 x 1.5	M16 x 1.5	M18 x 1.5	M20 x 1.5	M22 x 1.5	M27 x 2.0	M33 x 2.0	M42 x 2.0	M48 x 2.0
OD Nom.	10.0	12.0	14.0	16.0	18.0	20.0	22.0	27.0	33.0	42.0	48.0
ID Min.	8.9	10.3	12.3	14.3	16.3	18.3	20.3	24.8	30.8	39.8	45.8
A Max.	1.0	1.5	1.5	1.5	2.0	2.0	2.0	2.0	2.5	2.5	2.5
B Min.	10.0	11.5	11.5	13.0	14.5	14.5	15.5	19.0	19.0	19.5	22.0
B1 Min.	11.5	14.0	14.0	15.5	16.5	16.5	18.0	22.0	22.0	22.5	25.0
C Min.	4.5	6.0	7.5	9.0	11.0	12.0	14.0	18.0	23.0	30.0	36.0
D	14.5	17.5	19.5	22.5	24.5	27.5	27.5	32.5	41.5	50.5	55.5
D1 Min.	20.0	23.0	25.0	28.0	30.0	32.0	34.0	40.0	49.0	60.0	66.0
D2 Min.	14.5	17.5	19.5	22.5	24.5	25.5	27.5	32.5	41.5	50.5	55.5
D3 $\begin{smallmatrix} +0.1 \\ 0 \\ -0.4 \end{smallmatrix}$	11.1	13.8	15.8	17.8	19.8	21.8	23.8	29.4	35.4	44.4	50.4
E $\begin{smallmatrix} +0.4 \\ 0 \end{smallmatrix}$	1.6	2.4	2.4	2.4	2.4	2.4	2.4	3.1	3.1	3.1	3.1
K $\pm 1$	12°	15°	15°	15°	15°	15°	15°	15°	15°	15°	15°
L	9.0	9.0	10.5	12.0	13.5	13.5	14.0	17.0	17.0	17.5	20.0
*O.Ring	8.1 x t1.6	9.3 x t2.2	11.3 x t2.2	13.3 x t2.2	15.3 x t2.2	17.3 x t2.2	19.3 x t2.2	23.6 x t2.9	29.6 x t2.9	38.6 x t2.9	44.6 x t2.9
Assembly torque (Nm)	15	25	35	40	45	55	60	130	160	210	260

Standard O-Rings : NBR SHORE-A 85  $\pm 5$  (Max. temp. rang. -30°C +120°C). Additional compounds are available on request. For special applications, please contact our technical department.

## 37° Flared Tube Fittings

### ISO/BSP Parallel Thread Ports (ISO 1179)

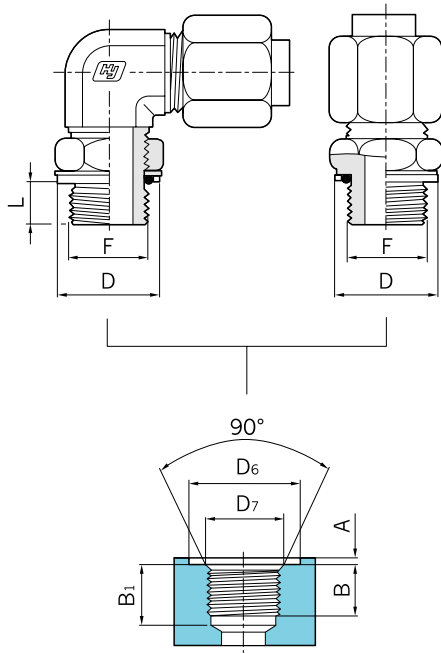

O-Ring and retaining ring sealing.

Spot-faced surface must be square to thread in port.

Machining operation such as A and D6 is not required when port surface complies with requirements.

### Table of Dimensions

Division \ F (Thread size)	G 1/8	G 1/4	G 3/8	G 1/2	G 3/4	G 1	G 1 1/4	G 1 1/2
OD Nom.	9.7	13.1	16.6	20.9	26.4	33.2	41.9	47.8
ID Min.	8.6	11.4	14.9	18.6	24.1	30.3	38.9	44.8
A Max.	1.0	1.5	2.0	2.5	2.5	2.5	2.5	2.5
B Min.	8.5	12.5	12.5	15.0	16.5	19.0	21.5	22.5
B <sub>1</sub> Min.	10.5	15.5	15.5	19.0	20.5	24.0	26.5	27.5
D	15.0	19.5	23.5	28.5	34.5	43.5	52.5	60.0
D <sub>6</sub> Min.	15.0	20.0	25.0	28.0	33.0	41.0	51.0	60.0
D <sub>7</sub>	9.8	13.2	16.7	21.0	26.5	33.3	42.0	47.9
L (Ref.)	6.5	9.0	9.5	11.5	13.5	15.0	16.0	16.0
O-Ring	8.0 x t2.0	10.77 x t2.62	13.94 x t2.62	17.8 x t2.6	23.47 x t2.62	29.74 x t3.53	37.69 x t3.53	44.04 x t3.53
Assembly torque (Nm)	18	35	70	90	180	310	450	540

Standard O-Rings : NBR SHORE-A 85 ±5 (Max. temp. rang. -30°C +120°C). Additional compounds are available on request. For special applications, please contact our technical department.

## Metric Parallel Thread Seal Ports (ISO 9974-1)

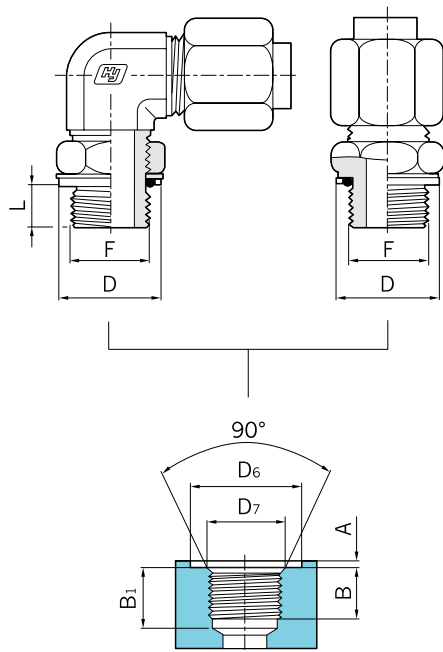

O-Ring and retaining ring sealing.

Spot-faced surface must be square to thread in port.

Machining operation such as A and D1 is not required when port surface complies with requirements.

### Table of Dimensions

F (Thread) Division	M10 x 1.0	M12 x 1.5	M14 x 1.5	M16 x 1.5	M18 x 1.5	M20 x 1.5	M22 x 1.5	M26 x 1.5	M27 x 2.0	M33 x 2.0	M42 x 2.0	M48 x 2.0	
OD Nom.	10.0	12.0	14.0	16.0	18.0	20.0	22.0	26.0	27.0	33.0	42.0	48.0	
ID Min.	8.9	10.3	12.3	14.3	16.3	18.3	20.3	24.3	24.8	30.8	39.8	45.8	
A Max.	1.0	1.5	1.5	1.5	2.0	2.0	2.5	2.5	2.5	2.5	2.5	2.5	
B Min.	8.0	12.0	12.0	12.0	12.0	14.0	14.0	16.0	16.0	18.0	20.0	22.0	
B <sub>1</sub> Min.	10.0	15.0	15.0	15.0	15.0	17.0	17.0	19.0	20.0	22.0	24.0	36.0	
D	14.7	17.7	19.7	21.7	23.7	25.7	27.7	31.7	32.7	39.7	49.7	54.9	
D <sub>6</sub> Min.	15.0	18.0	20.0	23.0	25.0	27.0	28.0	33.0	33.0	41.0	51.0	56.0	
D <sub>7</sub>	10.0	12.0	14.0	16.0	20.0	20.0	22.0	26.0	26.0	33.0	42.0	48.0	
L	9.7	10.0	10.0	11.3	12.2	12.0	13.7	13.5	16.8	16.8	17.3	19.3	
O-Ring	8.1 x t1.6	9.3 x t2.2	11.3 x t2.2	13.3 x t2.2	15.3 x t2.2	17.3 x t2.2	19.3 x t2.2	KP-B-P24	23.6 x t2.9	29.6 x t2.9	38.6 x t2.9	44.6 x t2.9	
Assembly torque (Nm)	1)	18	35	45	55	70	120	160	250	270	310	450	540
	2)	18	35	45	55	70	140	180	180	220	310	450	600

Note : 1) Non-adjustable end.  
2) Adjustable end.

Standard O-Rings : NBR SHORE-A 85 ±5 (Max. temp. rang. -30°C +120°C). Additional compounds are available on request.  
For special applications, please contact our technical department.

## 37° Flared Tube Fittings

### NPTF Thread Seal

The sealing action being achieved by the male and female tapered threads is therefore suitable to withstand high pressures.

If required, the sealing action can be enhanced with auxiliary compounds or tapes.

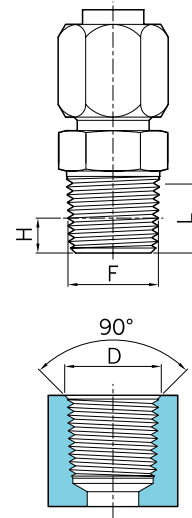

Division \ F (N)	1/8-27	1/4-18	3/8-18	1/2-14	3/4-14	1 1/2	1 1/4-1 1/2	1 1/2-1 1/2
D	10.24	13.61	17.05	21.22	26.56	33.22	41.98	48.05
H	4.10	5.80	6.10	8.10	8.60	10.20	10.70	10.70
L Working Thread	6.70	10.00	10.50	13.50	14.00	17.00	18.00	18.50

### ISO/BSP Taper Thread Seals

The sealing is achieved by matching a male tapered and female parallel threads.

This type of seal is not recommended under high pressures.

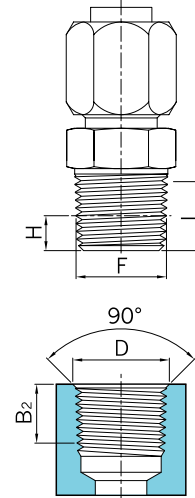

Division \ F (R)	1/8-28	1/4-19	3/8-19	1/2-14	3/4-14	1-14	1 1/4-11	1 1/2-11
B <sub>2</sub> Min.	5.50	8.50	8.50	10.50	13.00	14.50	17.00	17.00
D	9.72	13.15	16.66	20.95	26.44	33.24	41.91	47.80
H	4.00	6.00	6.40	8.20	9.50	10.40	12.70	12.70
L Working Thread	6.50	9.70	10.10	13.20	14.50	14.50	19.10	19.10

Standard O-Rings : NBR SHORE-A 85 ±5 (Max. temp. rang. -30°C +120°C). Additional compounds available on request.  
For special applications, please contact our technical department.

# Assembly Procedure For Radially Adjustable Fittings.

ON SAE, METRIC ISO 6149

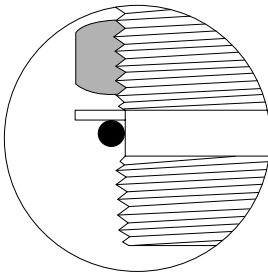
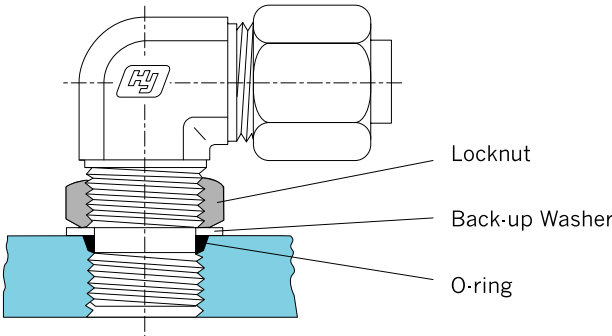

For adjustable positioning, O-ring and back-up washer should be in proper position on non-threaded section nearest to locknut. Lubrication of O-ring is recommended.

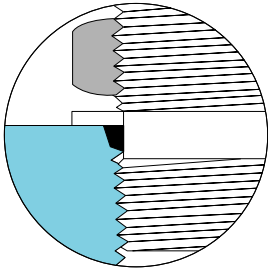

Screw fitting by hand into straight thread port until back-up washer contacts face of port.

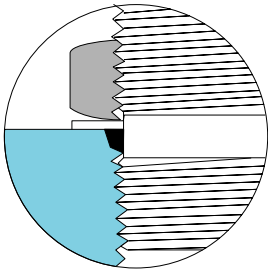

To position fitting, unscrew up to one full turn then hold fitting in desired position and tighten locknut until back-up washer contacts face of port and force O-Ring within port cavity.

## 37° Flared Tube Fittings

### Assembly Procedure For Radially Adjustable Fittings.

ON SAE, METRIC ISO 6149, BSPP ISO 1179

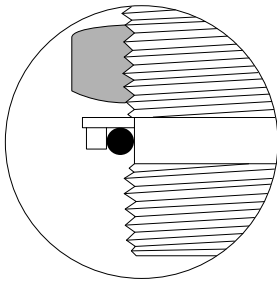
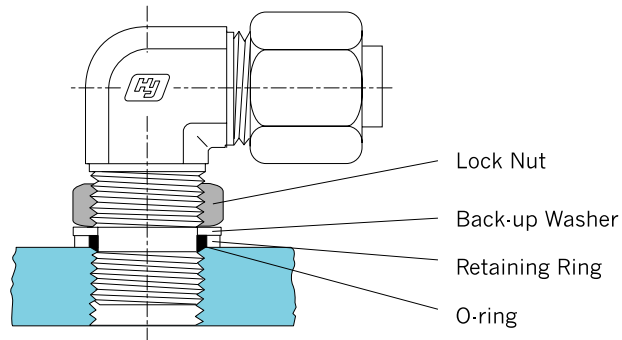

For adjustable positioning, O-ring and back-up washer should be in proper position on non-threaded section nearest to locknut. Lubrication of O-ring is recommended.

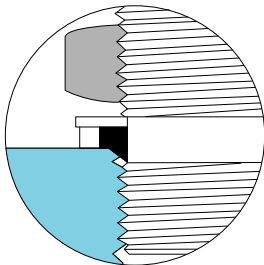

Screw fitting by hand into straight thread port until check washer contacts face of port.

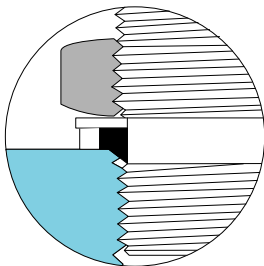

To position fitting, unscrew up to one full turn then hold fitting in desired position and tighten locknut until check washer is in contact with face of port.

## Special Fittings.

### Coding Procedure

Fittings having thread combinations other than those listed in our catalogue can be ordered provided the following conditions are met :

- The geometric shape of any new fitting meets with those in the table below.
- The nominal dimension of the new fitting's ends are shown in our catalogue.
- The new fitting envelope dimensions will be those originated by the biggest thread.

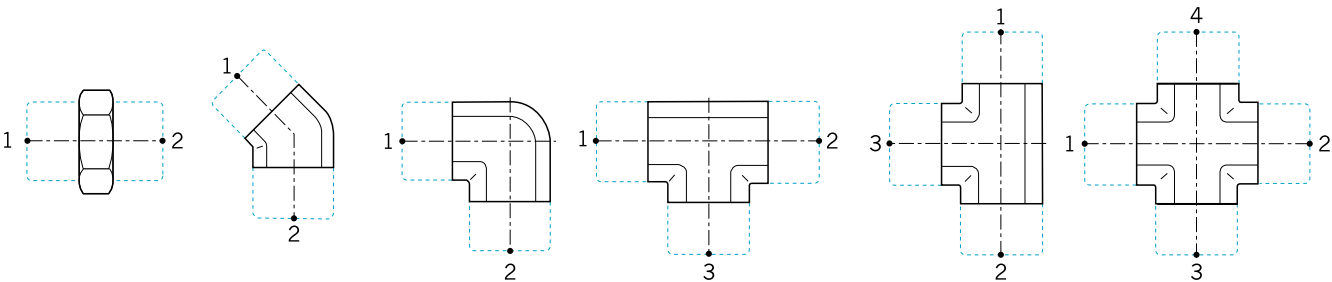

### Examples :

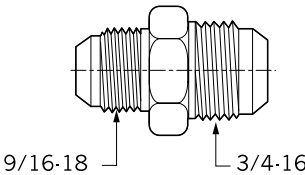

Should you wish a fitting in page 16 with following threads:  
 FUR (9/16-18) (3/4-16) this will be by encoded as : FUR 8T · 6T.

Example 1. Tube to Tube Connection

FUR 8T · 6T · S316  
 1 2 5

Option (O-Ring Seal)

FOUR 8T · 6T · S316  
 1 2 5

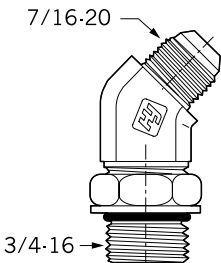

From page 37 you may order :  
 FOLMB (7/16-20) (3/4-16) by for encoded as FOLMB 4T · 08U.

Example 2. Tube to Tube Connection

FOLMB 4T · 08U · S316  
 1 2 3 5

Option (O-Ring Seal)

FOOLMB 4T · 08U · S316  
 1 2 3 5

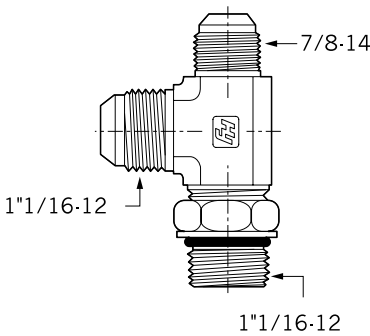

From page 39 you may order :  
 FORTM · (7/8-14) (1"1/16-12) (1"1/16-12) by for encoded as FORTM 10T 12T · 12U.

Example 3. Tube to Tube Connection

FORTM 10T12T · 12U · S316  
 1 2 3 5

Option (O-Ring Seal)

FOORTM 10T12T · 12U · S316  
 1 2 3 5

1. Name of Fittings	: "Refer to index" (Complete fitting)
2. Tube O.D	: See Tubing Designator
3. Thread Connection	: See Thread Designator
4. Elastomer Seal	: O-Ring
5. Material	: See Material Designator

## 37° Flared Tube Fittings

### Tube Designator

Inch Tube

Tube O.D	1/4"	3/8"	1/2"	.....	1-1/2"	2"
Identifier	4T	6T	8T	.....	24T	32T

Metric Tube

Tube O.D	4mm	6mm	8mm	.....	38mm	42mm
Identifier	4M	6M	8M	.....	38M	42M

### Thread Designator

Pipe Thread

Nomial Size	1/8	1/4	3/8	1/2	3/4	1	1-1/4	1-1/2
Identifier	01	02	03	04	06	08	10	12

Unified Thred

Size	7/16	9/16	3/4	7/8	1-5/16	1-5/16	1-5/8
Identifier	04	06	08	10	12	16	20

Thread Symbol

Size	Symbol	Specification
Taper Thread	R	BS 21 (BSPT), ISO 7/1
	N	ASME / ANSI B1. 20. 1 (NPT)
Parallel Thread	G	BS 2779 (BSPP), ISO 228/1
	U	ASME B1.1 (Unified)

### Material designator

Material	Stainless Steel	Carbon Steel	Brass
Identifier	S316 / 316L	STEL	BRAS

**EZY MAT - II** Portable flaring machine



Overall dimensions : 400 x 400 x 230. Weight : 50 Kg.



Flaring device



Pressure switch



Clamping grip













- Benefit :
- Very easy operating.
  - Ensure Constant quality.
  - Quick flaring time.











Caution!  
Do not actuate the flaring cone without first inserting the tube.











**Clamping grips for EZY MAT - II**

Tube O.D (mm.)	Part No.	Tube O.D (in.)	Part No.
6	M-FG06	1/4	M-FG04T
8	M-FG08	5/16	M-FG05T
10	M-FG10	3/8	M-FG06T
12	M-FG12	1/2	M-FG08T
14	M-FG14		
15	M-FG15		
16	M-FG16	5/8	M-FG10T
18	M-FG18		
20	M-FG20	3/4	M-FG12T
22	M-FG22	7/8	M-FG14T
25	M-FG25	1	M-FG16T
28	M-FG28		
30	M-FG30		
32	M-FG32	1-1/4	M-FG20T
35	M-FG35		
38	M-FG38	1-1/2	M-FG24T
42	M-FG42		











## 37° Flared Tube Fittings

Union <b>FU</b>		18
Union Elbow <b>FL</b>		18
Union Tee <b>FT</b>		19
Union Cross <b>FC</b>		19
Bulkhead Union <b>FBU</b>		20
Weld Bulkhead Union <b>FBUW</b>		20
Female Bulkhead Union <b>FBFC</b>		21
Bulkhead Union Elbow <b>FBL</b>		21
Male Connector <b>FMC</b>		22
Male Elbow <b>FLM</b>		22
Male Run Tee <b>FRTM</b>		23
Branch Tee <b>FBTM</b>		23

45° Male Elbow <b>FLMB</b>		24
Female Connector <b>FFC</b>		24
Female Elbow <b>FLF</b>		25
Female Run Tee <b>FRTF</b>		25
Female Branch Tee <b>FBTF</b>		26
O-Ring Seal Male Connector. (PF) <b>FOMR</b>		26
O-Ring Seal Male Connector.(UNF) <b>FOM</b>		27
O-Ring Seal Male Elbow.(UNF) <b>FOLM</b>		27
O-Ring Seal 45° Male Elbow.(UNF) <b>FOLMB</b>		28
O-Ring Seal Branch Tee.(UNF) <b>FOBTM</b>		28
O-Ring Seal Run Tee.(UNF) <b>FORTM</b>		29
Swivel Connector. <b>FSFMC</b>		29

O-Ring Seal Swivel Connector (UNF) <b>FSFOM</b>		30
Swivel Female Connector. <b>FSFFC</b>		30
Swivel Elbow. <b>FSL</b>		31
Swivel Run Tee. <b>FSRT</b>		31
Swivel Branch Tee. <b>FSBT</b>		32
Nut <b>FN</b>		32
Sleeve <b>FS</b>		33
Plug <b>FP</b>		33
Plug Cap <b>FPC</b>		34
Tube End Reducer <b>FTER</b>		34
Bulkhead Lock Nut <b>N-</b>		35

SAE J514 Flareless Tube Fittings

Union <b>BU</b>		<b>39</b>
Union Elbow <b>BL</b>		<b>39</b>
Union Tee <b>BT</b>		<b>40</b>
Union Cross <b>BC</b>		<b>40</b>
Bulkhead Union <b>BBU</b>		<b>41</b>
Large Hex Union <b>BUH</b>		<b>41</b>
Male Connector <b>BMC</b>		<b>42</b>
Male Elbow <b>BLM</b>		<b>43</b>
45° Male Elbow <b>BLMB</b>		<b>44</b>
Male Run Tee <b>BRTM</b>		<b>44</b>
Male Branch Tee <b>BBTM</b>		<b>45</b>

O-ring Seal Male Connector <b>BOM</b>		<b>45</b>
O-ring Seal Male Elbow <b>BOLM</b>		<b>46</b>
O-Ring Seal 45° Male Elbow <b>BOLMB</b>		<b>46</b>
O-ring Seal Run Tee <b>BORTM</b>		<b>47</b>
O-ring Seal Branch Tee <b>BOBTM</b>		<b>47</b>
O-ring Seal Long Male Elbow <b>BOLLM</b>		<b>48</b>
Swivel Elbow <b>BSL</b>		<b>48</b>
Swivel Run Tee <b>BSRT</b>		<b>49</b>
Swivel Branch Tee <b>BSBT</b>		<b>49</b>
Female Connector <b>BFC</b>		<b>50</b>
Female Elbow <b>BLF</b>		<b>50</b>

Female Run Tee <b>BRTF</b>		<b>51</b>
Female Branch Tee <b>BBTF</b>		<b>51</b>
Hose Male Union <b>BHUM</b>		<b>52</b>
Hose Bulkhead Male Union <b>BHBM</b>		<b>52</b>
Reducer <b>BR</b>		<b>53</b>
Plug <b>BP</b>		<b>54</b>
Cap <b>BCA</b>		<b>54</b>
Nut <b>BN</b>		<b>55</b>
Sleeve <b>BS</b>		<b>55</b>
Bulkhead Union Elbow <b>BBL</b>		<b>55</b>

## 37° Flared Tube Fittings

### Union

**FU**

SAE 070101 MS51501

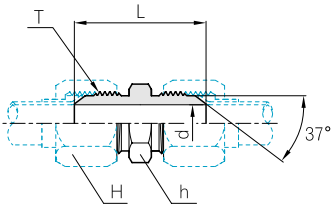

Part No.	Tube O.D.		T Straight Thread Size	d	Width across flat		L
	in	mm			h	H	
FU - 2T	1/8	3	5/16 - 24	1.6	11.1	9.5	29.7
FU - 3T	3/16	4	3/8 - 24	3.2	11.1	11.1	31.2
FU - 4T	1/4	6	7/16 - 20	4.4	12.7	14.2	34.8
FU - 5T	5/16	8	1/2 - 20	6.0	14.2	15.8	34.8
FU - 6T	3/8	10	9/16 - 18	7.5	15.8	17.4	35.8
FU - 8T	1/2	12	3/4 - 16	9.9	20.6	22.2	41.1
FU - 10T	5/8	16	7/8 - 14	12.3	23.8	25.4	47.8
FU - 12T	3/4	18,20	1 1/16 - 12	15.5	28.5	31.7	54.9
FU - 14T	7/8	22	1 3/16 - 12	18.0	31.7	34.9	56.1
FU - 16T	1	25	1 5/16 - 12	21.5	34.9	38.1	57.2
FU - 20T	1-1/4	32	1 5/8 - 12	27.5	46.0	50.0	61.7
FU - 24T	1-1/2	38	1 7/8 - 12	33.3	50.0	57.2	69.8
FU - 32T	2	50	2 1/2 - 12	45.0	70.0	75.0	86.4

### Union Elbow

**FL**

SAE 070201 MS51505

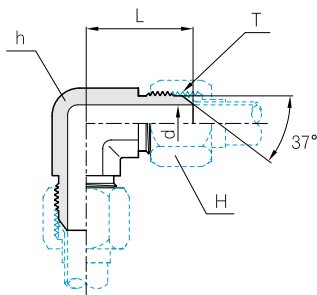

Part No.	Tube O.D.		T Straight Thread Size	d	Width across flat		L
	in	mm			h	H	
FL - 2T	1/8	3	5/16 - 24	1.6	11.1	9.5	19.6
FL - 3T	3/16	4	3/8 - 24	3.2	11.1	11.1	21.1
FL - 4T	1/4	6	7/16 - 20	4.4	11.1	14.2	22.6
FL - 5T	5/16	8	1/2 - 20	6.0	14.2	15.8	24.1
FL - 6T	3/8	10	9/16 - 18	7.5	14.2	17.4	26.9
FL - 8T	1/2	12	3/4 - 16	9.9	19.1	22.2	31.8
FL - 10T	5/8	16	7/8 - 14	12.3	22.2	25.4	36.8
FL - 12T	3/4	18,20	1 1/16 - 12	15.5	27.0	31.7	42.2
FL - 14T	7/8	22	1 3/16 - 12	18.0	33.3	34.9	45.7
FL - 16T	1	25	1 5/16 - 12	21.5	33.3	38.1	46.0
FL - 20T	1-1/4	32	1 5/8 - 12	27.5	41.2	50.0	52.3
FL - 24T	1-1/2	38	1 7/8 - 12	33.3	47.6	57.2	59.2
FL - 32T	2	50	2 1/2 - 12	45.0	63.5	75.0	77.7

All dimensions are in millimeters unless otherwise specified. Dimensions are for reference only, subject to change.

Union Tee

**FT**

SAE 070401 MS51510

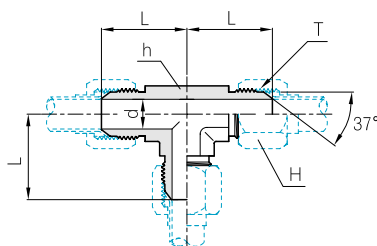

Part No.	Tube O.D.		T Straight Thread Size	d	Width across flat		L
	in	mm			h	H	
FT - 2T	1/8	3	5/16 - 24	1.6	11.1	9.5	19.6
FT - 3T	3/16	4	3/8 - 24	3.2	11.1	11.1	21.1
FT - 4T	1/4	6	7/16 - 20	4.4	11.1	14.2	22.6
FT - 5T	5/16	8	1/2 - 20	6.0	14.2	15.8	24.1
FT - 6T	3/8	10	9/16 - 18	7.5	14.2	17.4	26.9
FT - 8T	1/2	12	3/4 - 16	9.9	19.1	22.2	31.8
FT - 10T	5/8	16	7/8 - 14	12.3	22.2	25.4	36.8
FT - 12T	3/4	18,20	1 1/16 - 12	15.5	27.0	31.7	42.2
FT - 14T	7/8	22	1 3/16 - 12	18.0	33.3	34.9	45.7
FT - 16T	1	25	1 5/16 - 12	21.5	34.9	38.1	46.0
FT - 20T	1-1/4	32	1 5/8 - 12	27.5	41.2	50.0	52.3
FT - 24T	1-1/2	38	1 7/8 - 12	33.3	47.6	57.2	59.2
FT - 32T	2	50	2 1/2 - 12	45.0	63.5	75.0	77.7

Union Cross

**FC**

SAE 070501 MS51517

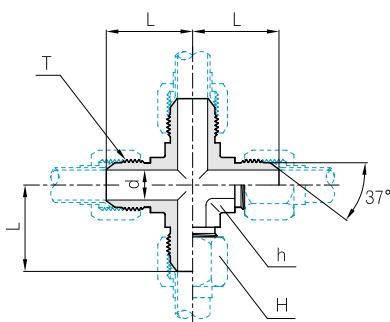

Part No.	Tube O.D.		T Straight Thread Size	d	Width across flat		L
	in	mm			h	H	
FC - 2T	1/8	3	5/16 - 24	1.6	11.1	9.5	19.6
FC - 3T	3/16	4	3/8 - 24	3.2	11.1	11.1	21.1
FC - 4T	1/4	6	7/16 - 20	4.4	11.1	14.2	22.6
FC - 5T	5/16	8	1/2 - 20	6.0	14.2	15.8	24.1
FC - 6T	3/8	10	9/16 - 18	7.5	14.2	17.4	26.9
FC - 8T	1/2	12	3/4 - 16	9.9	19.1	22.2	31.8
FC - 10T	5/8	16	7/8 - 14	12.3	22.2	25.4	36.8
FC - 12T	3/4	18,20	1 1/16 - 12	15.5	27.0	31.7	42.2
FC - 14T	7/8	22	1 3/16 - 12	18.0	33.3	34.9	45.7
FC - 16T	1	25	1 5/16 - 12	21.5	34.9	38.1	46.0
FC - 20T	1-1/4	32	1 5/8 - 12	27.5	41.2	50.0	52.3
FC - 24T	1-1/2	38	1 7/8 - 12	33.3	47.6	57.2	59.2
FC - 32T	2	50	2 1/2 - 12	45.0	63.5	75.0	77.7

All dimensions are in millimeters unless otherwise specified. Dimensions are for reference only, subject to change.

## 37° Flared Tube Fittings

### Bulkhead Union

## FBU

SAE 070601 MS51520

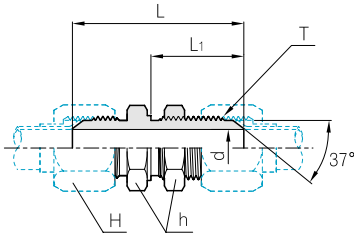

Part No.	Tube O.D.		T Straight Thread Size	d	Width across flat		L	L <sub>1</sub>
	in	mm			h	H		
FBU - 2T	1/8	3	5/16 - 24	1.6	14.2	9.5	47.5	28.2
FBU - 3T	3/16	4	3/8 - 24	3.2	15.8	11.1	48.3	28.2
FBU - 4T	1/4	6	7/16 - 20	4.4	17.4	14.2	52.6	30.5
FBU - 5T	5/16	8	1/2 - 20	6.0	19.1	15.8	52.6	30.5
FBU - 6T	3/8	10	9/16 - 18	7.5	20.6	17.4	55.4	32.5
FBU - 8T	1/2	12	3/4 - 16	9.9	25.4	22.2	62.0	36.6
FBU - 10T	5/8	16	7/8 - 14	12.3	28.5	25.4	69.6	40.1
FBU - 12T	3/4	18,20	1 1/16 - 12	15.5	34.9	31.7	78.5	44.4
FBU - 14T	7/8	22	1 3/16 - 12	18.0	38.1	34.9	79.2	44.4
FBU - 16T	1	25	1 5/16 - 12	21.5	41.2	38.1	79.8	44.4
FBU - 20T	1-1/4	32	1 5/8 - 12	27.5	47.6	50.0	84.1	45.7
FBU - 24T	1-1/2	38	1 7/8 - 12	33.3	53.9	57.2	89.4	46.0
FBU - 32T	2	50	2 1/2 - 12	45.0	69.8	75.0	106.7	53.1

### Weld Bulkhead Union

## FBUW

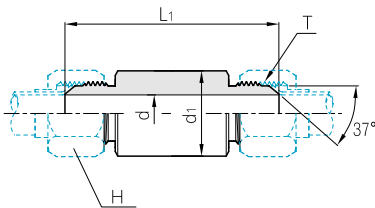

Part No.	Tube O.D.		T Straight Thread Size	d	d <sub>1</sub>	Width across flat H	L
	in	mm					
FBUW - 2T	1/8	3	5/16 - 24	1.6	11.0	9.5	70.0
FBUW - 3T	3/16	4	3/8 - 24	3.2	11.0	11.1	70.0
FBUW - 4T	1/4	6	7/16 - 20	4.4	14.0	14.2	80.0
FBUW - 5T	5/16	8	1/2 - 20	6.0	16.0	15.8	100.0
FBUW - 6T	3/8	10	9/16 - 18	7.5	17.0	17.4	100.0
FBUW - 8T	1/2	12	3/4 - 16	9.9	22.0	22.2	100.0
FBUW - 10T	5/8	16	7/8 - 14	12.3	25.0	25.4	110.0
FBUW - 12T	3/4	18,20	1 1/16 - 12	15.5	30.0	31.7	120.0
FBUW - 14T	7/8	22	1 3/16 - 12	18.0	32.0	34.9	130.0
FBUW - 16T	1	25	1 5/16 - 12	21.5	40.0	38.1	130.0
FBUW - 20T	1-1/4	32	1 5/8 - 12	27.5	46.0	50.0	140.0
FBUW - 24T	1-1/2	38	1 7/8 - 12	33.3	50.0	57.2	140.0
FBUW - 32T	2	50	2 1/2 - 12	45.0	70.0	75.0	150.0

All dimensions are in millimeters unless otherwise specified. Dimensions are for reference only, subject to change.

## Female Bulkhead Union FBFC

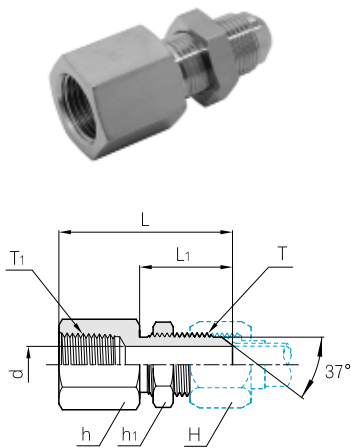

Part No.	Tube O.D.		T Straight Thread Size	T <sub>1</sub> * NPT Size	d	Width across flat			L	L <sub>1</sub>
	in	mm				h	h <sub>1</sub>	H		
FBFC 2T-01N	1/8	3	5/16 -24	1/8	1.6	14.2	14.2	9.5	41.2	28.2
FBFC 3T-01N	3/16	4	3/8 -24	1/8	3.2	14.2	15.8	11.1	41.2	28.2
FBFC 4T-01N	1/4	6	7/16 -20	1/8	4.4	17.4	17.4	14.2	46.7	30.5
FBFC 5T-01N	5/16	8	1/2 -20	1/8	6.0	19.1	19.1	15.8	43.5	30.5
FBFC 6T-02N	3/8	10	9/16 -18	1/4	7.5	20.6	20.6	17.4	52.3	32.5
FBFC 8T-03N	1/2	12	3/4 -16	3/8	9.9	25.4	25.4	22.2	54.4	36.6
FBFC10T-04N	5/8	16	7/8 -14	1/2	12.3	28.5	28.5	25.4	67.5	40.1
FBFC12T-06N	3/4	18,20	1 1/16 -12	3/4	15.5	34.9	34.9	31.7	73.9	44.4
FBFC14T-06N	7/8	22	1 3/16 -12	3/4	18.0	38.1	38.1	34.9	73.4	44.4
FBFC16T-08N	1	25	1 5/16 -12	1	21.5	41.2	41.2	38.1	78.5	44.4
FBFC20T-10N	1-1/4	32	1 5/8 -12	1-1/4	27.5	50.8	47.6	50.0	80.7	45.7
FBFC24T-12N	1-1/2	38	1 7/8 -12	1-1/2	33.3	53.9	53.9	57.2	85.1	46.0
FBFC32T-16N	2	50	2 1/2 -12	2	45.0	75.0	69.8	75.0	93.1	53.1

\* ISO Tapered Threads are available upon request.

## Bulkhead Union Elbow FBL

SAE 070701 MS51507

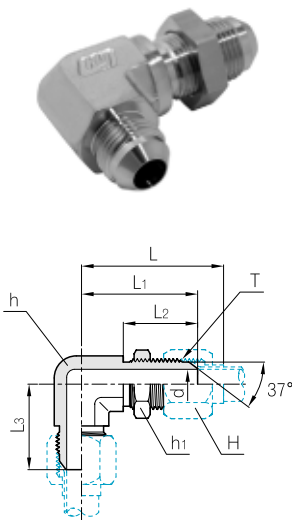

Part No.	Tube O.D.		T Straight Thread Size	d	Width across flat			L	L <sub>1</sub>	L <sub>2</sub>	L <sub>3</sub>
	in	mm			h	h <sub>1</sub>	H				
FBL - 2T	1/8	3	5/16 -24	1.6	11.1	14.2	9.5	45.9	38.1	23.4	22.4
FBL - 3T	3/16	4	3/8 -24	3.2	11.1	15.8	11.1	47.5	38.1	23.4	23.9
FBL - 4T	1/4	6	7/16 -20	4.4	11.1	17.4	14.2	49.5	40.4	25.9	24.6
FBL - 5T	5/16	8	1/2 -20	6.0	14.2	19.1	15.8	54.1	43.7	25.9	26.9
FBL - 6T	3/8	10	9/16 -18	7.5	14.2	20.6	17.4	57.9	46.0	27.7	27.7
FBL - 8T	1/2	12	3/4 -16	9.9	19.1	25.4	22.2	66.3	53.6	31.8	34.5
FBL - 10T	5/8	16	7/8 -14	12.3	22.2	28.5	25.4	77.3	60.7	35.8	39.6
FBL - 12T	3/4	18,20	1 1/16 -12	15.5	27.0	34.9	31.7	83.1	67.6	39.6	45.2
FBL - 14T	7/8	22	1 3/16 -12	18.0	33.3	38.1	34.9	88.7	71.1	39.6	48.8
FBL - 16T	1	25	1 5/16 -12	21.5	33.3	41.2	38.1	90.1	71.1	39.6	49.3
FBL - 20T	1-1/4	32	1 5/8 -12	27.5	41.2	47.6	50.0	97.7	79.2	40.9	55.1
FBL - 24T	1-1/2	38	1 7/8 -12	33.3	47.6	53.9	57.2	113.6	86.9	41.1	59.4
FBL - 32T	2"	50	2 1/2 -12	45.0	63.5	69.8	75.0	131.9	104.4	48.5	73.4

All dimensions are in millimeters unless otherwise specified. Dimensions are for reference only, subject to change.

## 37° Flared Tube Fittings

### Male Connector

## FMC

SAE 070102 MS51500

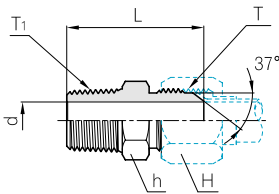

Part No.	Tube O.D.		T Straight Thread Size	T <sub>1</sub> * NPT Size	d	Width across flat		L
	in	mm				h	H	
FMC 2T-01N	1/8	3	5/16 - 24	1/8	1.6	11.1	9.5	28.2
FMC 3T-01N	3/16	4	3/8 - 24	1/8	3.2	11.1	11.1	29.0
FMC 4T-01N	1/4	6	7/16 - 20	1/8	4.4	12.7	14.2	31.0
FMC 5T-01N	5/16	8	1/2 - 20	1/8	6.0	14.2	15.8	31.0
FMC 6T-02N	3/8	10	9/16 - 18	1/4	7.5	15.8	17.4	36.3
FMC 8T-03N	1/2	12	3/4 - 16	3/8	9.9	20.6	22.2	38.9
FMC10T-04N	5/8	16	7/8 - 14	1/2	12.3	20.6	25.4	48.0
FMC12T-06N	3/4	18,20	1 1/16 - 12	3/4	15.5	28.5	31.7	52.3
FMC14T-06N	7/8	22	1 3/16 - 12	3/4	18.0	31.7	34.9	53.1
FMC16T-08N	1	25	1 5/16 - 12	1	21.5	34.9	38.1	58.4
FMC20T-10N	1-1/4	32	1 5/8 - 12	1-1/4	27.5	42.8	50.0	62.2
FMC24T-12N	1-1/2	38	1 7/8 - 12	1-1/2	33.3	50.8	57.2	68.1
FMC32T-16N	2	50	2 1/2 - 12	2	45.0	66.6	75.0	79.0

\* ISO Tapered Threads are available upon request.

### Male Elbow

## FLM

SAE 070202 MS51504

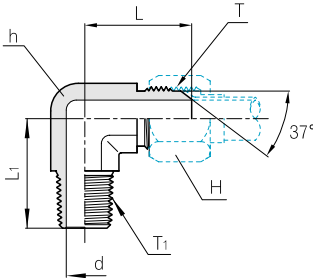

Part No.	Tube O.D.		T Straight Thread Size	T <sub>1</sub> * NPT Size	d	Width across flat		L	L <sub>1</sub>
	in	mm				h	H		
FLM 2T - 01N	1/8	3	5/16 - 24	1/8	1.6	11.1	9.5	19.6	18.3
FLM 3T - 01N	3/16	4	3/8 - 24	1/8	3.2	11.1	11.1	21.1	18.3
FLM 4T - 01N	1/4	6	7/16 - 20	1/8	4.4	11.1	14.2	22.6	19.8
FLM 5T - 01N	5/16	8	1/2 - 20	1/8	6.0	14.2	15.8	24.1	19.8
FLM 6T - 02N	3/8	10	9/16 - 18	1/4	7.5	14.2	17.4	26.9	27.7
FLM 8T - 03N	1/2	12	3/4 - 16	3/8	9.9	19.1	22.2	31.8	31.0
FLM10T - 04N	5/8	16	7/8 - 14	1/2	12.3	22.2	25.4	36.8	37.3
FLM12T - 06N	3/4	18,20	1 1/16 - 12	3/4	15.5	27.0	31.7	42.2	40.4
FLM14T - 06N	7/8	22	1 3/16 - 12	3/4	18.0	33.3	34.9	45.7	42.9
FLM16T - 08N	1	25	1 5/16 - 12	1	21.5	33.3	38.1	46.0	50.0
FLM20T - 10N	1-1/4	32	1 5/8 - 12	1-1/4	27.5	41.2	50.0	52.3	60.5
FLM24T - 12N	1-1/2	38	1 7/8 - 12	1-1/2	33.3	47.6	57.2	59.2	67.1
FLM32T - 16N	2	50	2 1/2 - 12	2	45.0	63.5	75.0	77.7	76.2

\* ISO Tapered Threads are available upon request.

All dimensions are in millimeters unless otherwise specified. Dimensions are for reference only, subject to change.

Male Run Tee

**FRTM**

SAE 070424 MS51511

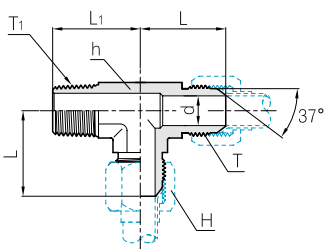

Part No.	Tube O.D.		T Straight Thread Size	T <sub>1</sub> * NPT Size	d	Width across flat		L	L <sub>1</sub>
	in	mm				h	H		
FRTM 2T - 01N	1/8	3	5/16 - 24	1/8	1.6	11.1	9.5	19.6	18.3
FRTM 3T - 01N	3/16	4	3/8 - 24	1/8	3.2	11.1	11.1	21.1	18.3
FRTM 4T - 01N	1/4	6	7/16 - 20	1/8	4.4	11.1	14.2	22.6	19.8
FRTM 5T - 01N	5/16	8	1/2 - 20	1/8	6.0	14.2	15.8	24.1	19.8
FRTM 6T - 02N	3/8	10	9/16 - 18	1/4	7.5	14.2	17.4	26.9	27.7
FRTM 8T - 03N	1/2	12	3/4 - 16	3/8	9.9	19.1	22.2	31.8	31.0
FRTM10T - 04N	5/8	16	7/8 - 14	1/2	12.3	22.2	25.4	36.8	37.3
FRTM12T - 06N	3/4	18,20	1 1/16 - 12	3/4	15.5	27.0	31.7	42.2	40.4
FRTM14T - 06N	7/8	22	1 3/16 - 12	3/4	18.0	33.3	34.9	45.7	42.9
FRTM16T - 08N	1	25	1 5/16 - 12	1	21.5	33.3	38.1	46.0	50.0
FRTM20T - 10N	1-1/4	32	1 5/8 - 12	1-1/4	27.5	41.2	50.0	52.3	60.5
FRTM24T - 12N	1-1/2	38	1 7/8 - 12	1-1/2	33.3	47.6	57.2	59.2	67.1
FRTM32T - 16N	2	50	2 1/2 - 12	2	45.0	63.5	75.0	77.7	76.2

\* ISO Tapered Threads are available upon request.

Branch Tee

**FBTM**

SAE 070425 MS51512

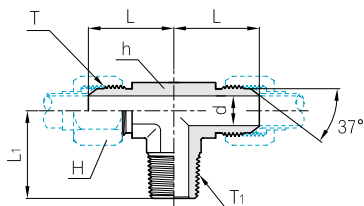

Part No.	Tube O.D.		T Straight Thread Size	T <sub>1</sub> * NPT Size	d	Width across flat		L	L <sub>1</sub>
	in	mm				h	H		
FBTM 2T - 01N	1/8	3	5/16 - 24	1/8	1.6	11.1	9.5	19.6	18.3
FBTM 3T - 01N	3/16	4	3/8 - 24	1/8	3.2	11.1	11.1	21.1	18.3
FBTM 4T - 01N	1/4	6	7/16 - 20	1/8	4.4	11.1	14.2	22.6	19.8
FBTM 5T - 01N	5/16	8	1/2 - 20	1/8	6.0	14.2	15.8	24.1	19.8
FBTM 6T - 02N	3/8	10	9/16 - 18	1/4	7.5	14.2	17.4	26.9	27.7
FBTM 8T - 03N	1/2	12	3/4 - 16	3/8	9.9	19.1	22.2	31.8	31.0
FBTM10T - 04N	5/8	16	7/8 - 14	1/2	12.3	22.2	25.4	36.8	37.3
FBTM12T - 06N	3/4	18,20	1 1/16 - 12	3/4	15.5	27.0	31.7	42.2	40.4
FBTM14T - 06N	7/8	22	1 3/16 - 12	3/4	18.0	33.3	34.9	45.7	42.9
FBTM16T - 08N	1	25	1 5/16 - 12	1	21.5	33.3	38.1	46.0	50.0
FBTM20T - 10N	1-1/4	32	1 5/8 - 12	1-1/4	27.5	41.2	50.0	52.3	60.5
FBTM24T - 12N	1-1/2	38	1 7/8 - 12	1-1/2	33.3	47.6	57.2	59.2	67.1
FBTM32T - 16N	2	50	2 1/2 - 12	2	45.0	63.5	75.0	77.7	76.2

\* ISO Tapered Threads are available upon request.

All dimensions are in millimeters unless otherwise specified. Dimensions are for reference only, subject to change.

## 37° Flared Tube Fittings

### 45° Male Elbow

## FLMB

SAE 070302 MS51508

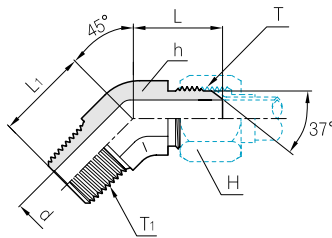

Part No.	Tube O.D.		T Straight Thread Size	T <sub>1</sub> * NPT Size	d	Width across flat		L	L <sub>1</sub>
	in	mm				h	H		
FLMB 2T - 01N	1/8	3	5/16 - 24	1/8	1.6	11.1	9.5	17.5	13.2
FLMB 3T - 01N	3/16	4	3/8 - 24	1/8	3.2	11.1	11.1	17.5	13.2
FLMB 4T - 01N	1/4	6	7/16 - 20	1/8	4.4	11.1	14.2	18.3	16.3
FLMB 5T - 01N	5/16	8	1/2 - 20	1/8	6.0	14.2	15.8	19.6	16.3
FLMB 6T - 02N	3/8	10	9/16 - 18	1/4	7.5	14.2	17.4	21.1	21.8
FLMB 8T - 03N	1/2	12	3/4 - 16	3/8	9.9	19.1	22.2	24.9	24.1
FLMB10T - 04N	5/8	16	7/8 - 14	1/2	12.3	22.2	25.4	28.2	29.7
FLMB12T - 06N	3/4	18,20	1 1/16 - 12	3/4	15.5	27.0	31.7	32.5	30.5
FLMB14T - 06N	7/8	22	1 3/16 - 12	3/4	18.0	33.3	34.9	36.8	33.0
FLMB16T - 08N	1	25	1 5/16 - 12	1	21.5	35.0	38.1	37.3	37.6
FLMB20T - 10N	1-1/4	32	1 5/8 - 12	1-1/4	27.5	41.2	50.0	40.4	42.4
FLMB24T - 12N	1-1/2	38	1 7/8 - 12	1-1/2	33.3	47.6	57.2	45.2	45.0
FLMB32T - 16N	2	50	2 1/2 - 12	2	45.0	63.5	75.0	56.4	53.6

\* ISO Tapered Threads are available upon request.

### Female Connector

## FFC

SAE 070103 MS51503

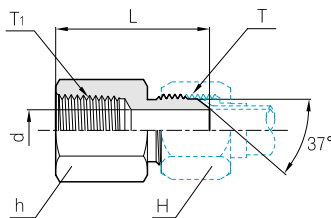

Part No.	Tube O.D.		T Straight Thread Size	T <sub>1</sub> * NPT Size	d	Width across flat		L
	in	mm				h	H	
FFC 2T - 01N	1/8	3	5/16 - 24	1/8	1.6	14.2	9.5	28.4
FFC 3T - 01N	3/16	4	3/8 - 24	1/8	3.2	14.2	11.1	28.7
FFC 4T - 01N	1/4	6	7/16 - 20	1/8	4.4	14.2	14.2	30.2
FFC 5T - 01N	5/16	8	1/2 - 20	1/8	6.0	14.2	15.8	29.7
FFC 6T - 02N	3/8	10	9/16 - 18	1/4	7.5	19.1	17.4	35.6
FFC 8T - 03N	1/2	12	3/4 - 16	3/8	9.9	22.2	22.2	39.6
FFC10T - 04N	5/8	16	7/8 - 14	1/2	12.3	28.5	25.4	48.0
FFC12T - 06N	3/4	18,20	1 1/16 - 12	3/4	15.5	34.9	31.7	52.3
FFC14T - 06N	7/8	22	1 3/16 - 12	3/4	18.0	34.9	34.9	52.3
FFC16T - 08N	1	25	1 5/16 - 12	1	21.5	41.2	38.1	59.7
FFC20T - 10N	1-1/4	32	1 5/8 - 12	1-1/4	27.5	50.8	50.0	63.2
FFC24T - 12N	1-1/2	38	1 7/8 - 12	1-1/2	33.3	60.3	57.2	66.5
FFC32T - 16N	2	50	2 1/2 - 12	2	45.0	73.0	75.0	75.4

\* ISO Tapered Threads are available upon request.

All dimensions are in millimeters unless otherwise specified. Dimensions are for reference only, subject to change.

Female Elbow

**FLF**

SAE 070203 MS51506

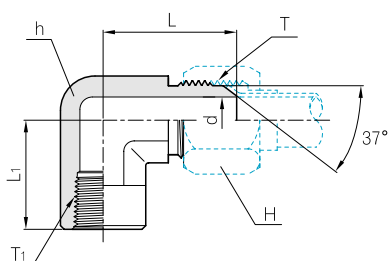

Part No.	Tube O.D.		T Straight Thread Size	T <sub>1</sub> * NPT Size	d	Width across flat		L	L <sub>1</sub>
	in	mm				h	H		
FLF 2T - 01N	1/8	3	5/16 - 24	1/8	1.6	14.2	9.5	25.4	16.8
FLF 3T - 01N	3/16	4	3/8 - 24	1/8	3.2	14.2	11.1	26.2	16.8
FLF 4T - 01N	1/4	6	7/16 - 20	1/8	4.4	14.2	14.2	27.4	16.8
FLF 5T - 01N	5/16	8	1/2 - 20	1/8	6.0	14.2	15.8	27.4	16.8
FLF 6T - 02N	3/8	10	9/16 - 18	1/4	7.5	19.1	17.4	31.2	22.4
FLF 8T - 03N	1/2	12	3/4 - 16	3/8	9.9	22.2	22.2	36.1	25.9
FLF10T - 04N	5/8	16	7/8 - 14	1/2	12.3	27.0	25.4	41.7	31.2
FLF12T - 06N	3/4	18.20	1 1/16 - 12	3/4	15.5	33.3	31.7	48.0	34.5
FLF14T - 06N	7/8	22	1 3/16 - 12	3/4	18.0	33.3	34.9	47.2	36.1
FLF16T - 08N	1	25	1 5/16 - 12	1	21.5	41.2	38.1	55.1	41.1
FLF20T - 10N	1-1/4	32	1 5/8 - 12	1-1/4	27.5	47.6	50.0	59.2	43.2
FLF24T - 12N	1-1/2	38	1 7/8 - 12	1-1/2	33.3	65.1	57.2	73.4	52.8
FLF32T - 16N	2	50	2 1/2 - 12	2	45.0	71.4	75.0	83.8	60.7

\* ISO Tapered Threads are available upon request.

Female Run Tee

**FRTF**

SAE 070426 MS51514

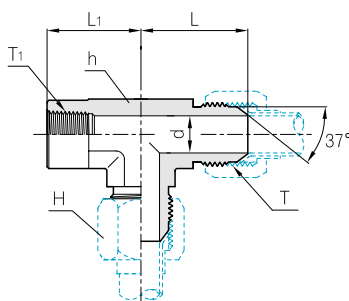

Part No.	Tube O.D.		T Straight Thread Size	T <sub>1</sub> * NPT Size	d	Width across flat		L	L <sub>1</sub>
	in	mm				h	H		
FRTF 2T - 01N	1/8	3	5/16 - 24	1/8	1.6	14.2	9.5	25.4	16.8
FRTF 3T - 01N	3/16	4	3/8 - 24	1/8	3.2	14.2	11.1	26.2	16.8
FRTF 4T - 01N	1/4	6	7/16 - 20	1/8	4.4	14.2	14.2	27.4	16.8
FRTF 5T - 01N	5/16	8	1/2 - 20	1/8	6.0	14.2	15.8	27.4	16.8
FRTF 6T - 02N	3/8	10	9/16 - 18	1/4	7.5	19.1	17.4	31.2	22.4
FRTF 8T - 03N	1/2	12	3/4 - 16	3/8	9.9	22.2	22.2	36.1	25.9
FRTF10T - 04N	5/8	16	7/8 - 14	1/2	12.3	27.0	25.4	41.7	31.2
FRTF12T - 06N	3/4	18.20	1 1/16 - 12	3/4	15.5	33.3	31.7	48.0	34.5
FRTF14T - 06N	7/8	22	1 3/16 - 12	3/4	18.0	33.3	34.9	47.2	36.1
FRTF16T - 08N	1	25	1 5/16 - 12	1	21.5	41.2	38.1	55.1	41.1
FRTF20T - 10N	1-1/4	32	1 5/8 - 12	1-1/4	27.5	47.6	50.0	59.2	43.2
FRTF24T - 12N	1-1/2	38	1 7/8 - 12	1-1/2	33.3	65.1	57.2	73.4	52.8
FRTF32T - 16N	2	50	2 1/2 - 12	2	45.0	71.4	75.0	83.8	60.7

\* ISO Tapered Threads are available upon request.

All dimensions are in millimeters unless otherwise specified. Dimensions are for reference only, subject to change.

## 37° Flared Tube Fittings

### Female Branch Tee

## FBTF

SAE 070427 MS51513

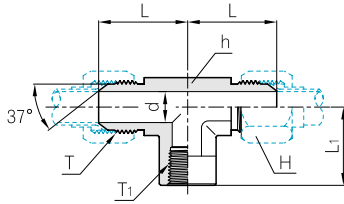

Part No.	Tube O.D.		T Straight Thread Size	T <sub>1</sub> * NPT Size	d	Width across flat		L	L <sub>1</sub>
	in	mm				h	H		
FBTF 2T - 01N	1/8	3	5/16 - 24	1/8	1.6	14.2	9.5	25.4	16.8
FBTF 3T - 01N	3/16	4	3/8 - 24	1/8	3.2	14.2	11.1	26.2	16.8
FBTF 4T - 01N	1/4	6	7/16 - 20	1/8	4.4	14.2	14.2	27.4	16.8
FBTF 5T - 01N	5/16	8	1/2 - 20	1/8	6.0	14.2	15.8	27.4	16.8
FBTF 6T - 02N	3/8	10	9/16 - 18	1/4	7.5	19.1	17.4	31.2	22.4
FBTF 8T - 03N	1/2	12	3/4 - 16	3/8	9.9	22.2	22.2	36.1	25.9
FBTF10T - 04N	5/8	16	7/8 - 14	1/2	12.3	27.0	25.4	41.7	31.2
FBTF12T - 06N	3/4	18,20	1 1/16 - 12	3/4	15.5	33.3	31.7	48.0	34.5
FBTF14T - 06N	7/8	22	1 3/16 - 12	3/4	18.0	33.3	34.9	47.2	36.1
FBTF16T - 08N	1	25	1 5/16 - 12	1	21.5	41.2	38.1	55.1	41.1
FBTF20T - 10N	1-1/4	32	1 5/8 - 12	1-1/4	37.5	47.6	50.0	59.2	43.2
FBTF24T - 12N	1-1/2	38	1 7/8 - 12	1-1/2	33.0	65.1	57.2	73.4	52.8
FBTF32T - 16N	2	50	2 1/2 - 12	2	45.0	71.4	75.0	83.8	60.7

\* ISO Tapered Threads are available upon request.

### O-Ring Seal Male Connector

## FOMR

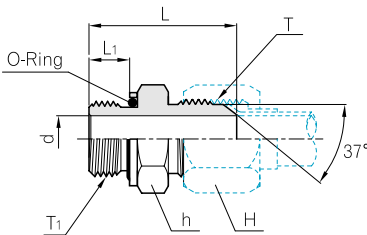

Part No.	Tube O.D.		T Straight Thread Size	T <sub>1</sub> (G) ISO Thread Size	d	Width across flat		L	L <sub>1</sub>
	in	mm				h	H		
FOMR 4T - 01G	1/4	6	7/16 - 20	1/8	4.4	17.0	14.2	28.7	6.2
FOMR 5T - 01G	5/16	8	1/2 - 20	1/8	6.0	17.0	15.8	28.7	6.2
FOMR 6T - 02G	3/8	10	9/16 - 18	1/4	7.5	19.1	17.4	32.0	9.3
FOMR 8T - 03G	1/2	12	3/4 - 16	3/8	9.9	22.2	22.2	36.0	9.3
FOMR10T - 04G	5/8	16	7/8 - 14	1/2	12.3	30.0	25.4	43.9	12.6
FOMR12T - 06G	3/4	18,20	1 1/16 - 12	3/4	15.5	36.0	31.7	47.5	12.6
FOMR16T - 08G	1	25	1 5/16 - 12	1	21.5	46.0	38.1	53.6	15.9
FOMR20T - 10G	1-1/4	32	1 5/8 - 12	1-1/4	27.5	50.0	50.0	56.4	15.9
FOMR24T - 12G	1-1/2	38	1 7/8 - 12	1-1/2	33.3	55.0	57.2	61.0	15.9
FOMR32T - 16G	2"	50	2 1/2 - 12	2	45.0	70.0	75.0	80.5	25.0

All dimensions are in millimeters unless otherwise specified. Dimensions are for reference only, subject to change.

O-Ring Seal Male Connector (UNF)

**FOM**

SAE 070120 MS51525

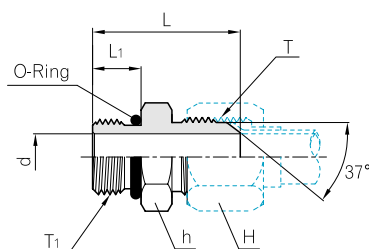

Part No.	Tube O.D.		T Straight Thread Size	T <sub>1</sub> SAE/MS Straight Thread Size	d	Width across flat		L	L <sub>1</sub>
	in	mm				h	H		
FOM 2T - 02U	1/8	3	5/16 - 24	5/16 - 24	1.6	11.1	9.5	26.9	7.5
FOM 3T - 03U	3/16	4	3/8 - 24	3/8 - 24	3.2	12.7	11.1	27.9	7.5
FOM 4T - 04U	1/4	6	7/16 - 20	7/16 - 20	4.4	14.2	14.2	31.2	9.1
FOM 5T - 05U	5/16	8	1/2 - 20	1/2 - 20	6.0	15.8	15.8	31.2	9.1
FOM 6T - 06U	3/8	10	9/16 - 18	9/16 - 18	7.5	17.4	17.4	33.0	9.9
FOM 8T - 08U	1/2	12	3/4 - 16	3/4 - 16	9.9	22.2	22.2	37.6	11.1
FOM10T - 10U	5/8	16	7/8 - 14	7/8 - 14	12.3	25.4	25.4	43.2	12.7
FOM12T - 12U	3/4	18.20	1 1/16 - 12	1 1/16 - 12	15.5	31.7	31.7	50.0	15.1
FOM14T - 14U	7/8	22	1 3/16 - 12	1 3/16 - 12	18.0	34.9	34.9	50.5	15.1
FOM16T - 16U	1	25	1 5/16 - 12	1 5/16 - 12	21.5	38.1	38.1	51.8	15.1
FOM20T - 20U	1-1/4	32	1 5/8 - 12	1 5/8 - 12	27.5	47.6	50.0	55.1	15.1
FOM24T - 24U	1-1/2	38	1 7/8 - 12	1 7/8 - 12	33.3	53.9	57.2	60.2	15.1
FOM32T - 32U	2	50	2 1/2 - 12	2 1/2 - 12	45.0	69.8	75.0	70.6	15.1

O-Ring Seal Male Elbow (UNF)

**FOLM**

SAE 070220 MS51527

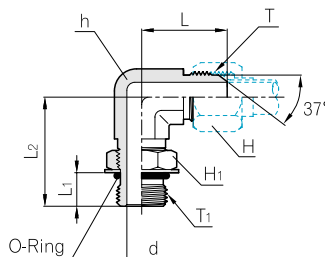

Part No.	Tube O.D.		T Straight Thread Size	T <sub>1</sub> SAE/MS Straight Thread Size	d	Width across flat			L	L <sub>1</sub>	L <sub>2</sub>
	in	mm				h	H	H <sub>1</sub>			
FOLM 2T - 02U	1/8	3	5/16 - 24	5/16 - 24	1.6	11.1	9.5	11.1	19.6	8.4	23.9
FOLM 3T - 03U	3/16	4	3/8 - 24	3/8 - 24	3.2	11.1	11.1	12.7	21.1	8.4	23.9
FOLM 4T - 04U	1/4	6	7/16 - 20	7/16 - 20	4.4	11.1	14.2	14.2	22.6	9.8	26.2
FOLM 5T - 05U	5/16	8	1/2 - 20	1/2 - 20	6.0	14.2	15.8	15.8	24.1	9.8	28.7
FOLM 6T - 06U	3/8	10	9/16 - 18	9/16 - 18	7.5	14.2	17.4	17.4	26.9	11.0	31.8
FOLM 8T - 08U	1/2	12	3/4 - 16	3/4 - 16	9.9	19.1	22.2	22.2	31.8	12.5	36.8
FOLM10T - 10U	5/8	16	7/8 - 14	7/8 - 14	12.3	22.2	25.4	25.4	36.8	14.3	43.2
FOLM12T - 12U	3/4	18.20	1 1/16 - 12	1 1/16 - 12	15.5	27.0	31.7	31.7	42.2	16.5	49.3
FOLM14T - 14U	7/8	22	1 3/16 - 12	1 3/16 - 12	18.0	33.3	34.9	34.9	45.7	16.5	50.8
FOLM16T - 16U	1	25	1 5/16 - 12	1 5/16 - 12	21.5	33.3	38.1	38.1	46.0	16.5	52.1
FOLM20T - 20U	1-1/4	32	1 5/8 - 12	1 5/8 - 12	27.5	41.2	50.0	47.6	52.3	16.5	57.2
FOLM24T - 24U	1-1/2	38	1 7/8 - 12	1 7/8 - 12	33.3	47.6	57.2	53.9	59.2	16.5	60.7
FOLM32T - 32U	2	50	2 1/2 - 12	2 1/2 - 12	45.0	63.5	75.0	69.8	77.7	16.5	73.4

All dimensions are in millimeters unless otherwise specified. Dimensions are for reference only, subject to change.

## 37° Flared Tube Fittings

### O-Ring Seal 45° Male Elbow (UNF)

#### FOLMB

SAE 070320 MS51528

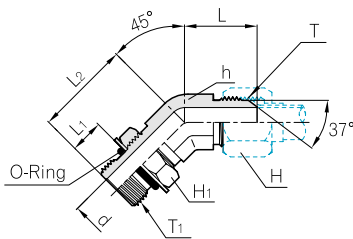

Part No.	Tube O.D.		T Straight Thread Size	T <sub>1</sub> SAE/MS Straight Thread Size	d	Width across flat			L	L <sub>1</sub>	L <sub>2</sub>
	in	mm				h	H	H <sub>1</sub>			
FOLMB 2T-02U	1/8	3	5/16 - 24	5/16 - 24	1.6	11.1	9.5	11.1	17.5	8.4	22.4
FOLMB 3T-03U	3/16	4	3/8 - 24	3/8 - 24	3.2	11.1	11.1	12.7	17.5	8.4	22.4
FOLMB 4T-04U	1/4	6	7/16 - 20	7/16 - 20	4.4	11.1	14.2	14.2	18.3	9.8	26.7
FOLMB 5T-05U	5/16	8	1/2 - 20	1/2 - 20	6.0	14.2	15.8	15.8	19.6	9.8	26.7
FOLMB 6T-06U	3/8	10	9/16 - 18	9/16 - 18	7.5	14.2	17.4	17.4	21.1	11.0	29.0
FOLMB 8T-08U	1/2	12	3/4 - 16	3/4 - 16	9.9	19.1	22.2	22.2	24.9	12.5	33.0
FOLMB10T-10U	5/8	16	7/8 - 14	7/8 - 14	12.3	22.2	25.4	25.4	28.2	14.3	38.6
FOLMB12T-12U	3/4	18.20	1 1/16 - 12	1 1/16 - 12	15.5	27.0	31.7	31.7	32.5	16.5	43.9
FOLMB14T-14U	7/8	22	1 3/16 - 12	1 3/16 - 12	18.0	33.3	34.9	34.9	36.8	16.5	47.2
FOLMB16T-16U	1	25	1 5/16 - 12	1 5/16 - 12	21.5	33.3	38.1	38.1	37.3	16.5	47.2
FOLMB20T-20U	1-1/4	32	1 5/8 - 12	1 5/8 - 12	27.5	41.2	50.0	47.6	40.4	16.5	48.5
FOLMB24T-24U	1-1/2	38	1 7/8 - 12	1 7/8 - 12	33.3	47.6	57.2	53.9	45.2	16.5	48.5
FOLMB32T-32U	2	50	2 1/2 - 12	2 1/2 - 12	45.0	63.5	75.0	69.8	56.4	16.5	47.2

### O-Ring Seal Branch Tee (UNF)

#### FOBTM

SAE 070429 MS51529

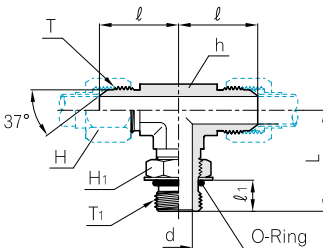

Part No.	Tube O.D.		T Straight Thread Size	T <sub>1</sub> SAE/MS Straight Thread Size	d	Width across flat			L	l	l <sub>1</sub>
	in	mm				h	H	H <sub>1</sub>			
FOBTM 2T-02U	1/8	3	5/16 - 24	5/16 - 24	1.6	11.1	9.5	11.1	23.9	19.6	8.4
FOBTM 3T-03U	3/16	4	3/8 - 24	3/8 - 24	3.2	11.1	11.1	12.7	23.9	21.1	8.4
FOBTM 4T-04U	1/4	6	7/16 - 20	7/16 - 20	4.4	11.1	14.2	14.2	26.2	22.6	9.8
FOBTM 5T-05U	5/16	8	1/2 - 20	1/2 - 20	6.0	14.2	15.8	15.8	28.7	24.1	9.8
FOBTM 6T-06U	3/8	10	9/16 - 18	9/16 - 18	7.5	14.2	17.4	17.4	31.8	26.9	11.0
FOBTM 8T-08U	1/2	12	3/4 - 16	3/4 - 16	9.9	19.1	22.2	22.2	36.8	31.8	12.5
FOBTM10T-10U	5/8	16	7/8 - 14	7/8 - 14	12.3	22.2	25.4	25.4	43.2	36.8	14.3
FOBTM12T-12U	3/4	18.20	1 1/16 - 12	1 1/16 - 12	15.5	27.0	31.7	31.7	49.3	42.2	16.5
FOBTM14T-14U	7/8	22	1 3/16 - 12	1 3/16 - 12	18.0	33.3	34.9	34.9	50.8	45.7	16.5
FOBTM16T-16U	1	25	1 5/16 - 12	1 5/16 - 12	21.5	33.3	38.1	38.1	52.1	46.0	16.5
FOBTM20T-20U	1-1/4	32	1 5/8 - 12	1 5/8 - 12	27.5	41.2	50.0	47.6	57.2	52.3	16.5
FOBTM24T-24U	1-1/2	38	1 7/8 - 12	1 7/8 - 12	33.3	47.6	57.2	53.9	60.7	59.2	16.5
FOBTM32T-32U	2	50	2 1/2 - 12	2 1/2 - 12	45.0	63.5	75.0	69.8	73.4	77.7	16.5

All dimensions are in millimeters unless otherwise specified. Dimensions are for reference only, subject to change.

O-Ring Seal Run Tee (UNF)

**FORTM**

SAE 070428 MS51530

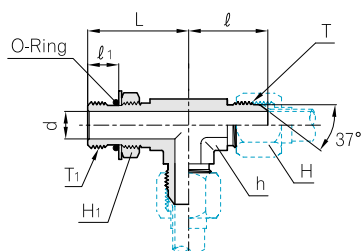

Part No.	Tube O.D.		T Straight Thread Size	T <sub>1</sub> SAE/MS Straight Thread Size	d	Width across flat			L	ℓ	ℓ <sub>1</sub>
	in	mm				h	H	H <sub>1</sub>			
FORTM 2T-02U	1/8	3	5/16 -24	5/16 -24	1.6	11.1	9.5	11.1	23.9	19.6	8.4
FORTM 3T-03U	3/16	4	3/8 -24	3/8 -24	3.2	11.1	11.1	12.7	23.9	21.1	8.4
FORTM 4T-04U	1/4	6	7/16 -20	7/16 -20	4.4	11.1	14.2	14.2	26.2	22.6	9.8
FORTM 5T-05U	5/16	8	1/2 -20	1/2 -20	6.0	14.2	15.8	15.8	28.7	24.1	9.8
FORTM 6T-06U	3/8	10	9/16 -18	9/16 -18	7.5	14.2	17.4	17.4	31.8	26.9	11.0
FORTM 8T-08U	1/2	12	3/4 -16	3/4 -16	9.9	19.1	22.2	22.2	36.8	31.8	12.5
FORTM10T-10U	5/8	16	7/8 -14	7/8 -14	12.3	22.2	25.4	25.4	43.2	36.8	14.3
FORTM12T-12U	3/4	18,20	1 1/16 -12	1 1/16 -12	15.5	27.0	31.7	31.7	49.3	42.2	16.5
FORTM14T-14U	7/8	22	1 3/16 -12	1 3/16 -12	18.0	33.3	34.9	34.9	50.8	45.7	16.5
FORTM16T-16U	1	25	1 5/16 -12	1 5/16 -12	21.5	33.3	38.1	38.1	52.1	46.0	16.5
FORTM20T-20U	1-1/4	32	1 5/8 -12	1 5/8 -12	27.5	41.2	50.0	47.6	57.2	52.3	16.5
FORTM24T-24U	1-1/2	38	1 7/8 -12	1 7/8 -12	33.3	47.6	57.2	53.9	60.7	59.2	16.5
FORTM32T-32U	2	50	2 1/2 -12	2 1/2 -12	45.0	63.5	75.0	69.8	73.4	77.7	16.5

Swivel Connector

**FSFMC**

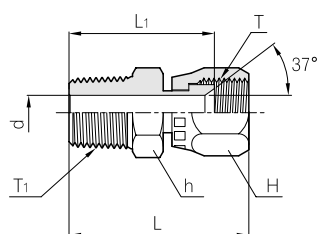

Part No.	Tube O.D.		T Straight Thread Size	T <sub>1</sub> NPT Size	d	Width across flat		L	L <sub>1</sub>
	in	mm				h	H		
FSFMC 4T-01N	1/4	6	7/16 -20	1/8	4.4	14.2	14.2	28.7	20.0
FSFMC 6T-02N	3/8	10	9/16 -18	1/4	7.5	17.4	17.4	40.4	30.9
FSFMC 8T-03N	1/2	12	3/4 -16	3/8	9.9	22.2	22.2	42.9	32.2
FSFMC10T-04N	5/8	16	7/8 -14	1/2	12.3	25.4	25.4	52.1	39.4
FSFMC12T-06N	3/4	18,20	1 1/16 -12	3/4	15.5	31.7	31.7	54.6	40.3
FSFMC16T-08N	1	25	1 5/16 -12	1	21.5	38.1	38.1	63.5	48.4
FSFMC20T-10N	1-1/4	32	1 5/8 -12	1-1/4	27.5	50.8	50.0	70.1	54.2
FSFMC24T-12N	1-1/2	38	1 7/8 -12	1-1/2	33.3	57.1	57.1	77.5	58.9
FSFMC32T-16N	2	50	2 1/2 -12	2	45.0	66.7	75.0	85.9	62.1

\* ISO Tapered Threads are available upon request.

All dimensions are in millimeters unless otherwise specified. Dimensions are for reference only, subject to change.

## 37° Flared Tube Fittings

### O-Ring Seal Swivel Connector (UNF) FSFOM

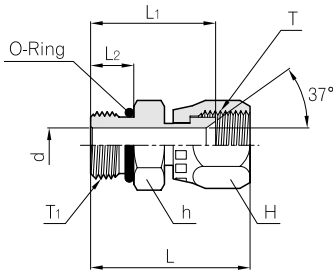

Part No.	Tube O.D.		T Straight Thread Size	T <sub>1</sub> SAE/MS Straight Thread Size	d	Width across flat		L	L <sub>1</sub>	L <sub>2</sub>
	in	mm				h	H			
FSFOM 4T-04U	1/4	6	7/16 - 20	7/16 - 20	4.4	14.2	14.2	33.3	24.6	9.1
FSFOM 5T-05U	5/16	8	1/2 - 20	1/2 - 20	6.0	15.8	15.8	34.3	24.8	9.1
FSFOM 6T-06U	3/8	10	9/16 - 18	9/16 - 18	7.5	17.4	17.4	36.3	26.8	9.9
FSFOM 8T-08U	1/2	12	3/4 - 16	3/4 - 16	9.9	22.2	22.2	40.9	30.2	11.1
FSFOM10T-10U	5/8	16	7/8 - 14	7/8 - 14	12.3	26.9	26.9	46.7	34.0	12.7
FSFOM12T-12U	3/4	18,20	1 1/16 - 12	1 1/16 - 12	15.5	31.8	31.7	52.6	38.3	15.1
FSFOM16T-16U	1	25	1 5/16 - 12	1 5/16 - 12	21.5	38.1	38.1	57.9	42.8	15.1
FSFOM20T-20U	1-1/4	32	1 5/8 - 12	1 5/8 - 12	27.5	50.0	50.0	63.2	47.4	15.1

### Swivel Female Connector FSFFC

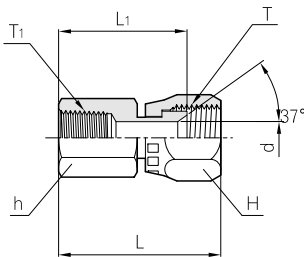

Part No.	Tube O.D.		T Straight Thread Size	T <sub>1</sub> * NPT Size	d	Width across flat		L	L <sub>1</sub>
	in	mm				h	H		
FSFFC 4T - 01N	1/4	6	7/16 - 20	1/8	4.4	14.2	14.2	32.1	23.4
FSFFC 6T - 02N	3/8	10	9/16 - 18	1/4	7.5	19.1	17.4	36.4	26.9
FSFFC 8T - 03N	1/2	12	3/4 - 16	3/8	9.9	22.2	22.2	40.7	31.2
FSFFC10T - 04N	5/8	16	7/8 - 14	1/2	12.3	28.5	25.4	48.0	37.3
FSFFC12T - 06N	3/4	18,20	1 1/16 - 12	3/4	15.5	34.9	31.7	51.1	38.4
FSFFC16T - 08N	1	25	1 5/16 - 12	1	21.5	41.2	38.1	62.1	47.0
FSFFC20T - 10N	1-1/4	32	1 5/8 - 12	1-1/4	27.5	50.0	50.0	71.0	55.1
FSFFC24T - 12N	1-1/2	38	1 7/8 - 12	1-1/2	33.3	60.0	60.0	76.0	57.4
FSFFC32T - 16N	2	50	2 1/2 - 12	2	45.0	75.0	75.0	86.0	62.2

\* ISO Tapered Threads are available upon request.

All dimensions are in millimeters unless otherwise specified. Dimensions are for reference only, subject to change.

Swivel Elbow

**FSL**

SAE 070221 MS51521

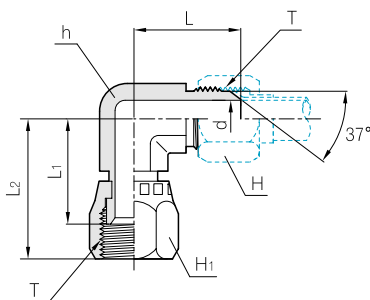

Part No.	Tube O.D.		T Straight Thread Size	d	Width across flat			L	L <sub>1</sub>	L <sub>2</sub>
	in	mm			h	H	H <sub>1</sub>			
FSL - 2T	1/8	3	5/16 - 24	1.6	11.1	9.5	11.1	19.6	16.7	24.6
FSL - 3T	3/16	4	3/8 - 24	3.2	11.1	11.1	12.7	21.1	17.1	25.4
FSL - 4T	1/4	6	7/16 - 20	4.4	11.1	14.2	14.2	22.6	16.7	25.4
FSL - 5T	5/16	8	1/2 - 20	6.0	14.2	15.8	15.8	24.1	17.4	26.9
FSL - 6T	3/8	10	9/16 - 18	7.5	14.2	17.4	17.4	26.9	22.3	31.8
FSL - 8T	1/2	12	3/4 - 16	9.9	19.1	22.2	22.2	31.8	24.4	35.1
FSL - 10T	5/8	16	7/8 - 14	12.3	22.2	25.4	25.4	36.8	28.4	41.1
FSL - 12T	3/4	18.20	1 1/16 - 12	15.5	27.0	31.7	31.7	42.2	30.1	44.4
FSL - 14T	7/8	22	1 3/16 - 12	18.0	33.3	34.9	34.9	45.7	30.5	45.2
FSL - 16T	1	25	1 5/16 - 12	21.5	33.3	38.1	38.1	46.0	35.7	50.8
FSL - 20T	1-1/4	32	1 5/8 - 12	27.5	41.2	50.0	50.0	52.3	42.8	58.7
FSL - 24T	1-1/2	38	1 7/8 - 12	33.3	47.6	57.2	57.2	59.2	47.2	65.8
FSL - 32T	2	50	2 1/2 - 12	45.0	63.5	75.0	75.0	77.7	62.1	85.9

Swivel Run Tee

**FSRT**

SAE 070432

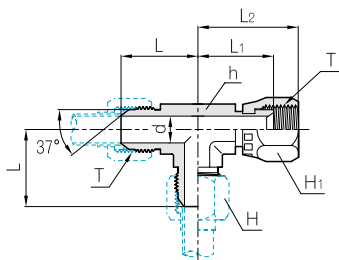

Part No.	Tube O.D.		T Straight Thread Size	d	Width across flat			L	L <sub>1</sub>	L <sub>2</sub>
	in	mm			h	H	H <sub>1</sub>			
FSRT - 2T	1/8	3	5/16 - 24	1.6	11.1	9.5	11.1	19.6	16.7	24.6
FSRT - 3T	3/16	4	3/8 - 24	3.2	11.1	11.1	12.7	21.1	17.1	25.4
FSRT - 4T	1/4	6	7/16 - 20	4.4	11.1	14.2	14.2	22.6	16.7	25.4
FSRT - 5T	5/16	8	1/2 - 20	6.0	14.2	15.8	15.8	24.1	17.4	26.9
FSRT - 6T	3/8	10	9/16 - 18	7.5	14.2	17.4	17.4	26.9	22.3	31.8
FSRT - 8T	1/2	12	3/4 - 16	9.9	19.1	22.2	22.2	31.8	24.4	35.1
FSRT - 10T	5/8	16	7/8 - 14	12.3	22.2	25.4	25.4	36.8	28.4	41.1
FSRT - 12T	3/4	18.20	1 1/16 - 12	15.5	27.0	31.7	31.7	42.2	30.1	44.4
FSRT - 14T	7/8	22	1 3/16 - 12	18.0	33.3	34.9	34.9	45.7	30.5	45.2
FSRT - 16T	1	25	1 5/16 - 12	21.5	33.3	38.1	38.1	46.0	35.7	50.8
FSRT - 20T	1-1/4	32	1 5/8 - 12	27.5	41.2	50.0	50.0	52.3	42.8	58.7
FSRT - 24T	1-1/2	38	1 7/8 - 12	33.3	47.6	57.2	57.2	59.2	47.2	65.8
FSRT - 32T	2	50	2 1/2 - 12	45.0	63.5	75.0	75.0	77.7	62.1	85.9

All dimensions are in millimeters unless otherwise specified. Dimensions are for reference only, subject to change.

## 37° Flared Tube Fittings

### Swivel Branch Tee

## FSBT

SAE 070433 MS51524

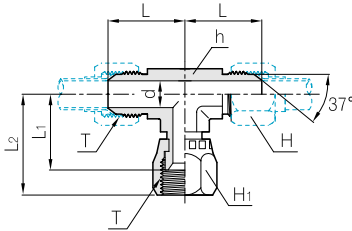

Part No.	Tube O.D.		T Straight Thread Size	d	Width across flat			L	L <sub>1</sub>	L <sub>2</sub>
	in	mm			h	H	H <sub>1</sub>			
FSBT - 2T	1/8	3	5/16 - 24	1.6	11.1	9.5	11.1	19.6	16.7	24.6
FSBT - 3T	3/16	4	3/8 - 24	3.2	11.1	11.1	12.7	21.1	17.1	25.4
FSBT - 4T	1/4	6	7/16 - 20	4.4	11.1	14.2	14.2	22.6	16.7	25.4
FSBT - 5T	5/16	8	1/2 - 20	6.0	14.2	15.8	15.8	24.1	17.4	26.9
FSBT - 6T	3/8	10	9/16 - 18	7.5	14.2	17.4	17.4	26.9	22.3	31.8
FSBT - 8T	1/2	12	3/4 - 16	9.9	19.1	22.2	22.2	31.8	24.4	35.1
FSBT - 10T	5/8	16	7/8 - 14	12.3	22.2	25.4	25.4	36.8	28.4	41.1
FSBT - 12T	3/4	18.20	1 1/16 - 12	15.5	27.0	31.7	31.7	42.2	30.1	44.4
FSBT - 14T	7/8	22	1 3/16 - 12	18.0	33.3	34.9	34.9	45.7	30.5	45.2
FSBT - 16T	1	25	1 5/16 - 12	21.5	33.3	38.1	38.1	46.0	35.7	50.8
FSBT - 20T	1-1/4	32	1 5/8 - 12	27.5	41.2	50.0	50.0	52.3	42.8	58.7
FSBT - 24T	1-1/2	38	1 7/8 - 12	33.3	47.6	57.2	57.2	59.2	47.2	65.8
FSBT - 32T	2	50	2 1/2 - 12	45.0	63.5	75.0	75.0	77.7	62.1	85.9

### Nut

## FN

SAE 070110 MS51531

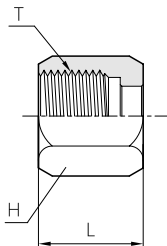

Part No.	Tube	T Straight Thread Size	Width	L
	O.D.		across flat	
	in		H	
FN - 2T	1/8	5/16 - 24	9.5	14.0
FN - 3T	3/16	3/8 - 24	11.1	15.5
FN - 4T	1/4	7/16 - 20	14.2	15.8
FN - 5T	5/16	1/2 - 20	15.8	17.3
FN - 6T	3/8	9/16 - 18	17.4	18.5
FN - 8T	1/2	3/4 - 16	22.2	21.6
FN - 10T	5/8	7/8 - 14	25.4	24.9
FN - 12T	3/4	1 1/16 - 12	31.7	26.2
FN - 14T	7/8	1 3/16 - 12	34.9	27.7
FN - 16T	1	1 5/16 - 12	38.1	28.7
FN - 20T	1-1/4	1 5/8 - 12	50.0	31.2
FN - 24T	1-1/2	1 7/8 - 12	57.2	36.1
FN - 32T	2	2 1/2 - 12	75.0	44.5

Part No.	Tube	T Straight Thread Size	Width	L
	O.D.		across flat	
	in		H	
FN - 3M	3	5/16 - 24	9.5	14.0
FN - 4M	4	3/8 - 24	11.1	15.5
FN - 6M	6	7/16 - 20	14.0	15.8
FN - 8M	8	1/2 - 20	17.0	17.3
FN - 10M	10	9/16 - 18	19.0	18.5
FN - 12M	12	3/4 - 16	22.0	21.6
FN - 16M	16	7/8 - 14	27.0	24.9
FN - 18M	18	1 1/16 - 12	32.0	26.2
FN - 20M	20	1 1/16 - 12	32.0	26.2
FN - 22M	22	1 3/16 - 12	36.0	27.7
FN - 25M	25	1 5/16 - 12	41.0	28.7
FN - 32M	32	1 5/8 - 12	50.0	31.2
FN - 38M	38	1 7/8 - 12	60.0	36.1
FN - 50M	50	2 1/2 - 12	75.0	44.5

All dimensions are in millimeters unless otherwise specified. Dimensions are for reference only, subject to change.

Sleeve

**FS**

SAE 070115 MS51533

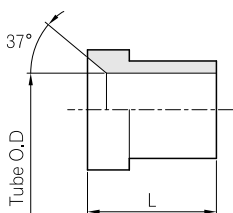

Part No.	Tube O.D.		L
	in	mm	
FS - 2T	1/8	3.2	8.6
FS - 3T	3/16	4.8	8.6
FS - 4T	1/4	6.4	10.4
FS - 5T	5/16	8.0	11.2
FS - 6T	3/8	9.6	12.7
FS - 8T	1/2	12.8	14.2
FS - 10T	5/8	16.0	16.8
FS - 12T	3/4	19.2	17.3
FS - 14T	7/8	22.4	19.3
FS - 16T	1	25.6	19.8
FS - 20T	1-1/4	31.8	23.1
FS - 24T	1-1/2	38.1	28.4
FS - 32T	2	50.8	30.2

Part No.	Tube O.D.		L
	in	mm	
FS - 3M	3/16	4.8	8.6
FS - 4M	1/4	6.4	8.6
FS - 6M	3/8	9.6	10.4
FS - 8M	1/2	12.8	11.2
FS - 10M	5/8	16.0	12.7
FS - 12M	3/4	19.2	14.2
FS - 16M	7/8	22.4	16.8
FS - 18M	1	25.6	17.3
FS - 20M	1-1/8	31.8	17.3
FS - 22M	1-1/4	31.8	19.3
FS - 25M	1-1/2	38.1	19.8
FS - 32M	1-3/4	44.5	23.1
FS - 38M	1-7/8	47.6	28.4
FS - 50M	2	50.8	30.2

Plug

**FP**

SAE 070109 MS51518

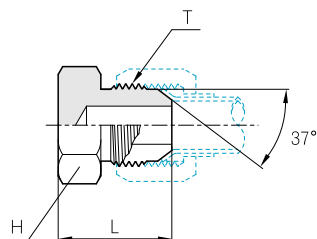

Part No.	Tube O.D.		T Straight Thread Size	Width across flat	L
	in	mm		H	
FP - 2T	1/8	3.2	5/16 - 24	11.1	17.8
FP - 3T	3/16	4.8	3/8 - 24	11.1	18.5
FP - 4T	1/4	6.4	7/16 - 20	12.7	20.3
FP - 5T	5/16	8.0	1/2 - 20	14.2	20.3
FP - 6T	3/8	9.6	9/16 - 18	15.8	21.3
FP - 8T	1/2	12.8	3/4 - 16	20.6	23.9
FP - 10T	5/8	16.0	7/8 - 14	23.8	27.9
FP - 12T	3/4	19.2	1 1/16 - 12	28.5	32.5
FP - 14T	7/8	22.4	1 3/16 - 12	31.7	33.3
FP - 16T	1	25.6	1 5/16 - 12	34.9	33.8
FP - 20T	1-1/4	31.8	1 5/8 - 12	42.8	36.8
FP - 24T	1-1/2	38.1	1 7/8 - 12	50.0	41.9
FP - 32T	2	50.8	2 1/2 - 12	70.0	52.1

All dimensions are in millimeters unless otherwise specified. Dimensions are for reference only, subject to change.

## 37° Flared Tube Fittings

### Plug Cap

## FPC

SAE 070112 MS51532

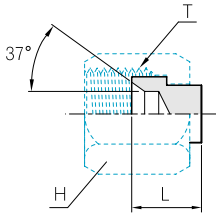

Part No.	Tube O.D.		T Straight Thread Size	Width across flat	L
	in	mm		H	
FPC - 2T	1/8	3	5/16 - 24	9.5	9.5
FPC - 3T	3/16	4	3/8 - 24	11.1	9.5
FPC - 4T	1/4	6	7/16 - 20	14.2	8.7
FPC - 5T	5/16	8	1/2 - 20	15.8	10.3
FPC - 6T	3/8	10	9/16 - 18	17.4	11.9
FPC - 8T	1/2	12	3/4 - 16	22.2	13.5
FPC - 10T	5/8	16	7/8 - 14	25.4	13.5
FPC - 12T	3/4	18,20	1 1/16 - 12	31.7	16.7
FPC - 14T	7/8	22	1 3/16 - 12	34.9	15.9
FPC - 16T	1	25	1 5/16 - 12	38.1	15.9
FPC - 20T	1-1/4	32	1 5/8 - 12	50.0	19.1
FPC - 24T	1-1/2	38	1 7/8 - 12	57.2	23.8
FPC - 32T	2	50	2 1/2 - 12	75.0	30.1

### Tube End Reducer

## FTER

SAE 070123 MS51534

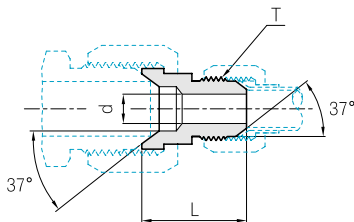

Part No.	Reducing Tube O.D.	T Straight Thread Size	d	L
FTER 6T - 4T	3/8 x 1/4	7/16 - 20	4.4	24.6
FTER 8T - 4T	1/2 x 1/4	7/16 - 20	4.4	25.4
FTER 8T - 6T	1/2 x 3/8	9/16 - 18	7.5	25.4
FTER10T - 4T	5/8 x 1/4	7/16 - 20	4.4	26.2
FTER10T - 6T	5/8 x 3/8	9/16 - 18	7.5	26.2
FTER12T - 4T	3/4 x 1/4	7/16 - 20	4.4	27.7
FTER12T - 6T	3/4 x 3/8	9/16 - 18	7.5	27.7
FTER12T - 8T	3/4 x 1/2	3/4 - 16	10.0	30.2
FTER16T - 12T	1 x 3/4	1-1/16 - 12	15.5	37.3
FTER20T - 12T	1-1/4 x 3/4	1-1/16 - 12	15.5	38.3
FTER20T - 16T	1-1/4 x 1	1-5/16 - 12	21.5	40.3
FTER24T - 20T	1-1/2 x 1-1/4	1-5/8 - 12	27.5	42.9

All dimensions are in millimeters unless otherwise specified. Dimensions are for reference only, subject to change.

## Lock Nut

**N-**

SAE 070118 MS51860

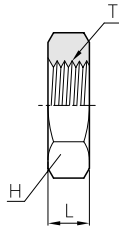

Part No.	Tube O.D.		T Straight Thread Size	Width across flat	L
	in	mm		H	
N - 0524U 14.2T 5.6	1/8	3	5/16 - 24	14.2	5.6
N - 0624U 15.8T 5.6	3/16	4	3/8 - 24	15.8	5.6
N - 0720U 17.4T 6.4	1/4	6	7/16 - 20	17.4	6.4
N - 0820U 19.1T 6.4	5/16	8	1/2 - 20	19.1	6.4
N - 0918U 20.6T 6.9	3/8	10	9/16 - 18	20.6	6.9
N - 1216U 25.4T 7.9	1/2	12	3/4 - 16	25.4	7.9
N - 1414U 28.5T 9.1	5/8	16	7/8 - 14	28.5	9.1
N - 1712U 34.9T 10.4	3/4	18,20	1-1/16 - 12	34.9	10.4
N - 1912U 38.1T 10.4	7/8	22	1-3/16 - 12	38.1	10.4
N - 2112U 41.0T 10.4	1	25	1-5/16 - 12	41.0	10.4
N - 2612U 47.6T 10.4	1-1/4	32	1-5/8 - 12	47.6	10.4
N - 3012U 54.0T 10.4	1-1/2	38	1-7/8 - 12	53.9	10.4
N - 4012U 70.0T 10.4	2	50	2-1/2 - 12	70.0	10.4

# SAE J514 Flareless Tube Fittings

The basic design of these fittings is derived from existing military standards.

## Design and Construction

The three components of the Flareless Tube fitting are designed and manufactured to produce a high pressure, leak-free joint upon proper assembly.

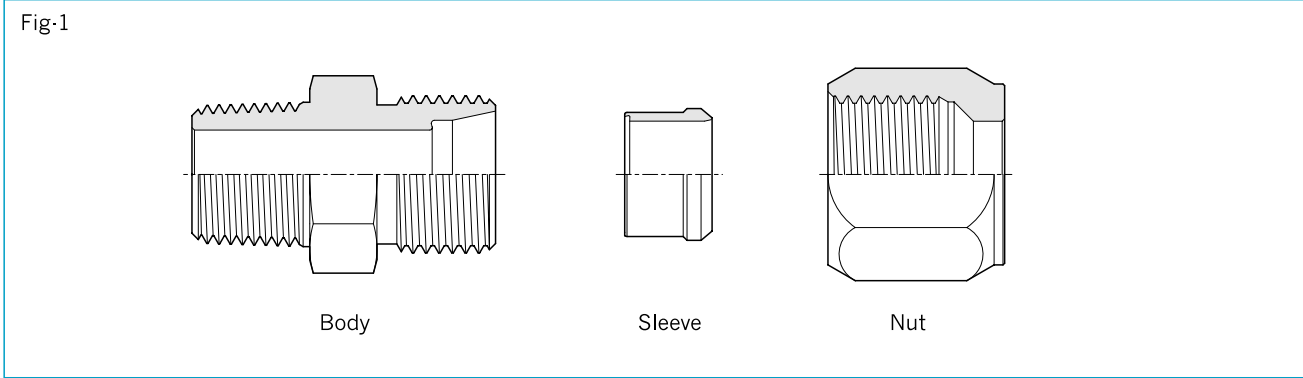

## Typical Material Specification

Material	Bar Stock	Forging
Stainless Steel Type 316	ASTM A479	ASTM A182
Brass	JIS C3604BD	JIS C3771BE
Carbon Steel	JIS S20C	JIS S20C

Details of Flareless Hydraulic Tube Fitting Assemblies

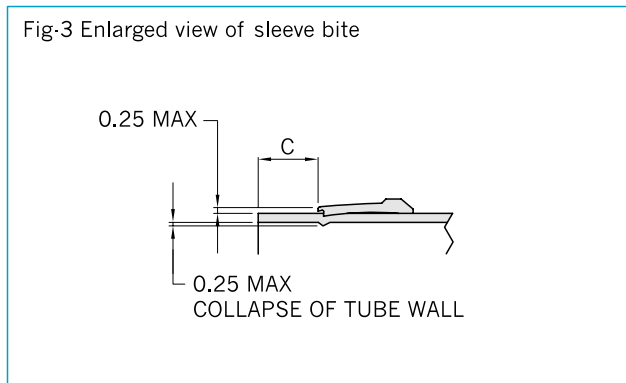
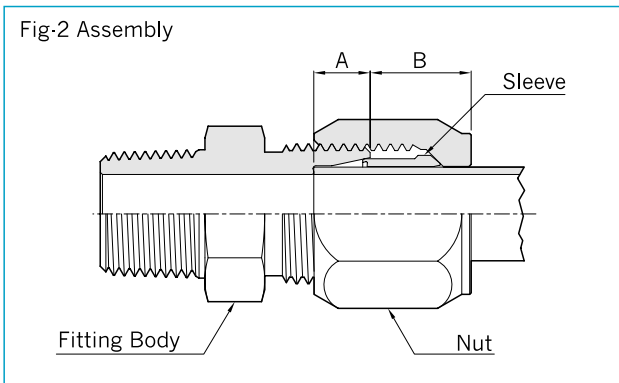

**Table 1-Dimesons of Flareless Hydraulic Tube Fitting Assemblies**

Nominal Tube O.D	A (Ref) mm	A (Ref) in.	B (Ref) mm	B (Ref) in.	C (Ref) mm	C (Ref) in.
1/8	4.78	0.188	7.9	0.31	2.0	0.08
3/16	5.94	0.234	8.6	0.34	3.0	0.12
1/4	5.94	0.234	10.7	0.42	3.6	0.14
5/16	6.35	0.250	10.7	0.42	3.6	0.14
3/8	6.35	0.250	11.9	0.47	3.6	0.14
1/2	7.75	0.305	12.7	0.50	3.6	0.14
5/8	8.89	0.350	13.5	0.53	3.6	0.14
3/4	8.89	0.350	14.2	0.56	3.6	0.14
7/8	8.89	0.350	13.5	0.53	-	-
1	10.54	0.415	16.8	0.66	4.3	0.17
1-1/4	10.54	0.415	18.3	0.72	5.1	0.20
1-1/2	12.32	0.485	18.3	0.72	5.1	0.20
2	12.32	0.485	21.3	0.84	5.1	0.20

## Assembly Instructions for Hydraulic Flareless Tube Fittings.

These instructions apply to the assembly of hydraulic tube fittings of the flareless type.

The following instructions should be used to assure proper make-up of the fitting when assembled since the fitting depends on securing the sleeve to the tube by the cutting action of the sleeve into the tube.

1. Cut tube square and burr inside and outside corner (not excessive).
2. Assemble fitting by sliding nut over tubing with open end out.  
Slide sleeve on tubing with cutting edge out, the large head end should be inside of the nut.  
Lubricate the Sleeve and the threads on the body and nut with oil or petrolatum. Insert tube into fitting.
3. Be sure of tubing bottoms into the fitting, and tighten the nut until the sleeve just grips the tube.  
With a little experience, the mechanic can determine this point by feel.  
If the fittings are bench assembled, the gripping action can be determined by rotating the tube by hand as the nut is drawn down. When the tube can no longer be turned by hand, the sleeve has started to grip the tube.
4. After the sleeve grips the tube, tighten the nut one full turn.  
This may vary slightly with different tubing materials, but for general practice, it is a good rule for the mechanic to follow.
5. The fittings can now be disassembled for inspection.

the pilot at the end of the sleeve should be contacting or be within 0.038 mm (0.0015 in) of the tube for hard material or not more than 0.13 mm (0.005 in) on soft material. See Figure 3 for further detail.

This is an indication that the cutting edge has performed its function and has taken a secure bite in the tube.

The sleeve should be slightly sprung or arched.

the rounded or lead edge should show a good seat in the fitting, and the head or shoulder end should be collapsed tight against the tube. The sleeve should have no end movement; however, the sleeve may be rotated on the tube due to spring back of the material. The performance of the fitting is not affected if the sleeve rotates.

6. In production, it may be preferable to use a threaded presetting tool to preform the sleeve onto the tubing.  
The presetting tool is a counterpart of the fitting hardened to provide good wearing properties for repeated usage.  
When using the presetting tool, the assembly instructions are the same, as the presetting tool takes the place of the fitting.  
Care should be taken to keep the cam surface of the presetting tool free of defects since they would transfer themselves to the sleeve, which would result in improper seating when the fitting is installed.
7. In some installations, it may be necessary to use a mandrel to support the inside of the tube when setting the sleeve.  
This is only necessary when the tube wall is so thin or so soft that it will not resist the biting action of the sleeve without collapsing.  
The mandrel in this instance supports the tube and allows the sleeve to bite into the tube without deforming or collapsing.  
Because the use of a mandrel allows very little give in the tubing, the setting of the sleeve may be made with slightly fewer turns than described previously.

## Reassembly Instructions for Hydraulic Flareless Tube Fittings.

After disassembly of the fitting joint, the flareless fitting can be reassembled

by assembling the tube and sleeve into the socket of the fitting and threading the nut onto the fitting.

The operation of assembly up to the point at which the sleeve seats itself in the fitting can usually be accomplished by hand or with the use of a small wrench. If a wrench is required, only low torques are necessary to seat the sleeve.

When the sleeve is seated, an increase in the torque will be quite evident. When this point is reached, draw the nut up approximately 1/6 of a turn minimum, but not more than 1/3 of a turn, to complete the tightening operation.



Union

**BU**

SAE 080101 MS51814

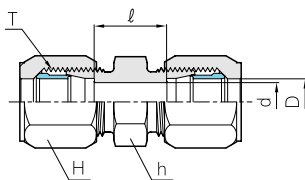

Part No.	Tube O.D D (in)	T Straight Thread Size	d	Width across flat		ℓ
				h	H	
BU - 2T	1/8	5/16 - 24	2.4	11.1	9.5	16.3
BU - 3T	3/16	3/8 - 24	3.2	11.1	11.1	16.3
BU - 4T	1/4	7/16 - 20	5.2	12.7	14.2	18.1
BU - 5T	5/16	1/2 - 20	6.0	14.2	15.8	17.3
BU - 6T	3/8	9/16 - 18	7.0	15.8	17.4	18.8
BU - 8T	1/2	3/4 - 16	10.7	20.6	22.2	20.6
BU - 10T	5/8	7/8 - 14	12.7	23.8	25.4	23.1
BU - 12T	3/4	1 1/16 - 12	16.6	28.5	31.7	28.2
BU - 14T	7/8	1 3/16 - 12	18.0	31.7	34.9	28.2
BU - 16T	1	1 5/16 - 12	22.2	34.9	38.1	24.9
BU - 20T	1 1/4	1 5/8 - 12	27.8	42.9	50.0	26.9
BU - 24T	1 1/2	1 7/8 - 12	34.1	50.0	57.2	25.2
BU - 32T	2	2 1/2 - 12	46.0	65.0	75.0	29.0

Union Elbow

**BL**

SAE 080201 MS51820

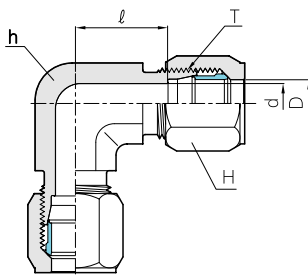

Part No.	Tube O.D D (in)	T Straight Thread Size	d	Width across flat		ℓ
				h	H	
BL - 2T	1/8	5/16 - 24	2.4	11.1	9.5	14.8
BL - 3T	3/16	3/8 - 24	3.2	11.1	11.1	15.2
BL - 4T	1/4	7/16 - 20	5.2	11.1	14.2	16.7
BL - 5T	5/16	1/2 - 20	6.0	14.2	15.8	17.8
BL - 6T	3/8	9/16 - 18	7.0	14.2	17.4	20.4
BL - 8T	1/2	3/4 - 16	10.7	19.1	22.2	24.1
BL - 10T	5/8	7/8 - 14	12.7	22.2	25.4	27.2
BL - 12T	3/4	1 1/16 - 12	16.6	26.9	31.7	31.2
BL - 14T	7/8	1 3/16 - 12	18.0	33.3	34.9	33.3
BL - 16T	1	1 5/16 - 12	22.2	33.3	38.1	33.4
BL - 20T	1 1/4	1 5/8 - 12	27.8	41.0	50.0	37.5
BL - 24T	1 1/2	1 7/8 - 12	34.1	47.6	57.2	39.0
BL - 32T	2	2 1/2 - 12	46.1	63.5	75.0	49.9

All dimensions are in millimeters unless otherwise specified. Dimensions are for reference only, subject to change.

# SAE J514 Flareless Tube Fittings

## Union Tee

### BT

SAE 080401 MS51811

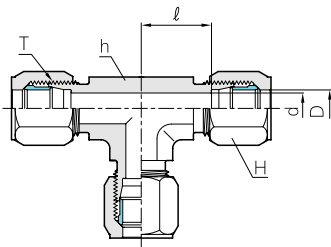

Part No.	Tube O.D D (in)	T Straight Thread Size	d	Width across flat		ℓ
				h	H	
BT - 2T	1/8	5/16 - 24	2.4	11.1	9.5	14.8
BT - 3T	3/16	3/8 - 24	3.2	11.1	11.1	15.2
BT - 4T	1/4	7/16 - 20	5.2	11.1	14.2	16.7
BT - 5T	5/16	1/2 - 20	6.0	14.2	15.8	17.8
BT - 6T	3/8	9/16 - 18	7.0	14.2	17.4	20.4
BT - 8T	1/2	3/4 - 16	10.7	19.1	22.2	24.1
BT - 10T	5/8	7/8 - 14	12.7	22.2	25.4	27.2
BT - 12T	3/4	1 1/16 - 12	16.6	27.0	31.7	31.2
BT - 14T	7/8	1 3/16 - 12	18.0	33.3	34.9	33.3
BT - 16T	1	1 5/16 - 12	22.2	33.3	38.1	33.4
BT - 20T	1 1/4	1 5/8 - 12	27.8	41.2	50.0	37.5
BT - 24T	1 1/2	1 7/8 - 12	34.1	47.6	57.2	39.0

## Union Cross

### BC

SAE 080501 MS51894

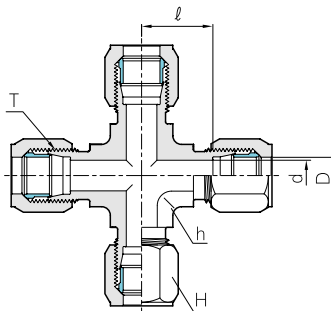

Part No.	Tube O.D D (in)	T Straight Thread Size	d	Width across flat		ℓ
				h	H	
BC - 4T	1/4	7/16 - 20	5.2	11.1	14.2	16.7
BC - 6T	3/8	9/16 - 18	7.2	14.2	17.4	20.4
BC - 8T	1/2	3/4 - 16	10.7	19.1	22.2	24.1
BC - 12T	3/4	1 1/16 - 12	16.7	27.0	31.8	31.2

All dimensions are in millimeters unless otherwise specified. Dimensions are for reference only, subject to change.

Bulkhead Union

**BBU**

SAE 080601 MS51812

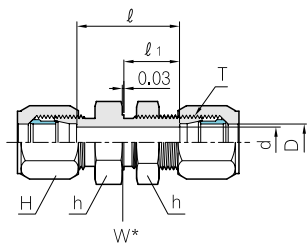

W\* - BULKHEAD PILOT DIA.  
RECOMMENDED CLEARANCE  
HOLE +0.015 OVER W DIA

Part No.	Tube O.D D (in)	T Straight Thread Size	d	Width across flat		ℓ	ℓ <sub>1</sub>	W	Max. Bulkhead Thickness
				h	H				
BBU - 4T	1/4	7/16 - 20	5.2	17.4	14.2	36.1	22.5	11.2	9.7
BBU - 6T	3/8	9/16 - 18	7.0	20.6	17.4	37.6	23.4	14.2	10.2
BBU - 8T	1/2	3/4 - 16	10.7	25.4	22.2	40.9	25.6	19.1	10.2
BBU - 10T	5/8	7/8 - 14	12.7	28.5	25.4	45.2	27.9	22.4	9.4
BBU - 12T	3/4	1 1/16 - 12	16.6	34.9	31.7	51.3	30.7	26.9	10.9
BBU - 16T	1	1 5/16 - 12	22.2	41.2	38.1	48.0	29.1	33.3	10.9

Large Hex Union

**BUH**

SAE 080119 MS51856

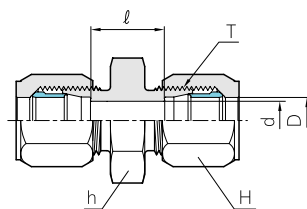
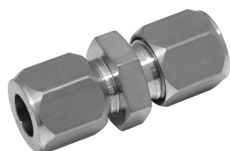

Part No.	Tube O.D D (in)	T Straight Thread Size	d	Width across flat		ℓ
				h	H	
BUH - 4T	1/4	7/16 - 20	5.2	17.4	14.2	18.1
BUH - 6T	3/8	9/16 - 18	7.0	20.6	17.4	18.8
BUH - 8T	1/2	3/4 - 16	10.7	25.4	22.2	20.6
BUH - 10T	5/8	7/8 - 14	12.7	28.5	25.4	23.1
BUH - 12T	3/4	1 1/16 - 12	16.6	34.9	31.7	28.2
BUH - 16T	1	1 5/16 - 12	22.2	41.2	34.9	24.9

All dimensions are in millimeters unless otherwise specified. Dimensions are for reference only, subject to change.

# SAE J514 Flareless Tube Fittings

## Male Connector

### BMC

SAE 080102 MS51819

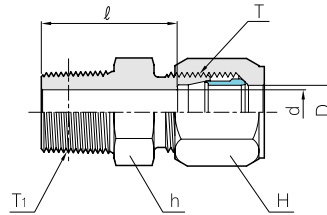

Part No.	Tube O.D D (in)	T Straight Thread Size	T <sub>1</sub> * NPT Size	d	Width across flat		l
					h	H	
BMC 2T - 01N	1/8	5/16 - 24	1/8	2.4	11.1	9.5	21.6
BMC 2T - 02N	1/8	5/16 - 24	1/4	2.4	14.2	9.5	26.7
BMC 3T - 01N	3/16	3/8 - 24	1/8	3.2	11.1	11.1	21.8
BMC 4T - 01N	1/4	7/16 - 20	1/8	5.2	12.7	14.2	22.5
BMC 4T - 02N	1/4	7/16 - 20	1/4	5.2	14.2	14.2	27.6
BMC 4T - 03N	1/4	7/16 - 20	3/8	5.2	19.1	14.2	27.8
BMC 4T - 04N	1/4	7/16 - 20	1/2	5.2	22.2	14.2	34.2
BMC 5T - 01N	5/16	1/2 - 20	1/8	6.0	14.2	15.8	22.1
BMC 5T - 02N	5/16	1/2 - 20	1/4	6.0	14.2	15.8	27.2
BMC 6T - 01N	3/8	9/16 - 18	1/8	7.0	15.8	17.4	22.9
BMC 6T - 02N	3/8	9/16 - 18	1/4	7.0	15.8	17.4	27.7
BMC 6T - 03N	3/8	9/16 - 18	3/8	7.0	19.1	17.4	27.9
BMC 6T - 04N	3/8	9/16 - 18	1/2	7.0	23.8	17.4	34.3
BMC 8T - 02N	1/2	3/4 - 16	1/4	10.7	20.6	22.2	28.8
BMC 8T - 03N	1/2	3/4 - 16	3/8	10.7	20.6	22.2	28.7
BMC 8T - 04N	1/2	3/4 - 16	1/2	10.7	22.2	22.2	35.2
BMC 8T - 06N	1/2	3/4 - 16	3/4	10.7	28.5	22.2	36.7
BMC 10T - 03N	5/8	7/8 - 14	3/8	12.7	23.8	25.4	30.7
BMC 10T - 04N	5/8	7/8 - 14	1/2	12.7	23.8	25.4	35.1
BMC 10T - 06N	5/8	7/8 - 14	3/4	12.7	28.5	25.4	37.3
BMC 12T - 04N	3/4	1 1/16 - 12	1/2	16.6	28.5	31.7	38.7
BMC 12T - 06N	3/4	1 1/16 - 12	3/4	16.6	28.5	31.7	38.9
BMC 14T - 06N	7/8	1 3/16 - 12	3/4	18.0	31.7	34.9	38.9
BMC 16T - 06N	1	1 5/16 - 12	3/4	22.2	34.9	38.1	37.2
BMC 16T - 08N	1	1 5/16 - 12	1	22.2	34.9	38.1	42.1
BMC 20T - 10N	1 1/4	1 5/8 - 12	1 1/4	27.8	42.9	50.0	44.9
BMC 24T - 12N	1 1/2	1 7/8 - 12	1 1/2	34.1	50.0	57.2	45.6
BMC 32T - 16N	2	2 1/2 - 12	2	46.0	69.9	75.0	50.2

\* ISO Tapered Threads are available upon request.

All dimensions are in millimeters unless otherwise specified. Dimensions are for reference only, subject to change.

## Male Elbow

## BLM

SAE 080202 MS51815

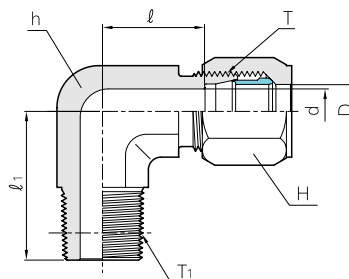

Part No.	Tube O.D D (in)	T Straight Thread Size	T <sub>1</sub> * NPT Size	d	Width across flat		l	l <sub>1</sub>
					h	H		
BLM 2T - 01N	1/8	5/16 - 24	1/8	2.4	11.1	9.5	15.0	18.3
BLM 3T - 01N	3/16	3/8 - 24	1/8	3.2	11.1	11.1	15.2	15.4
BLM 4T - 01N	1/4	7/16 - 20	1/8	5.2	11.1	14.2	16.5	16.7
BLM 4T - 02N	1/4	7/16 - 20	1/4	5.2	14.2	14.2	20.1	20.2
BLM 4T - 03N	1/4	7/16 - 20	3/8	5.2	19.1	14.2	22.6	22.8
BLM 5T - 01N	5/16	1/2 - 20	1/8	6.0	14.2	15.8	17.5	17.8
BLM 5T - 02N	5/16	1/2 - 20	1/4	6.0	14.2	15.8	19.6	19.8
BLM 6T - 01N	3/8	9/16 - 18	1/8	7.0	14.2	17.4	20.1	20.3
BLM 6T - 02N	3/8	9/16 - 18	1/4	7.0	14.2	17.4	20.1	20.3
BLM 6T - 03N	3/8	9/16 - 18	3/8	7.0	19.1	17.4	22.4	22.6
BLM 6T - 04N	3/8	9/16 - 18	1/2	7.0	22.2	17.4	24.6	24.9
BLM 8T - 02N	1/2	3/4 - 16	1/4	10.7	19.1	22.2	23.9	24.0
BLM 8T - 03N	1/2	3/4 - 16	3/8	10.7	19.1	22.2	23.9	24.0
BLM 8T - 04N	1/2	3/4 - 16	1/2	10.7	22.2	22.2	26.1	26.7
BLM 8T - 06N	1/2	3/4 - 16	3/4	10.7	27.0	22.2	28.2	28.3
BLM 10T - 03N	5/8	7/8 - 14	3/8	12.7	22.2	25.4	27.0	27.2
BLM 10T - 04N	5/8	7/8 - 14	1/2	12.7	22.2	25.4	27.0	27.2
BLM 12T - 04N	3/4	1 1/16 - 12	1/2	16.6	27.0	31.7	31.0	31.2
BLM 12T - 06N	3/4	1 1/16 - 12	3/4	16.6	27.0	31.7	31.0	31.2
BLM 14T - 06N	7/8	1 3/16 - 12	3/4	18.0	33.3	34.9	33.1	33.3
BLM 16T - 06N	1	1 5/16 - 12	3/4	22.2	33.3	38.1	33.2	33.4
BLM 16T - 08N	1	1 5/16 - 12	1	22.2	33.3	38.1	33.2	33.4
BLM 20T - 10N	1 1/4	1 5/8 - 12	1 1/4	27.8	41.2	50.0	37.3	37.4
BLM 24T - 12N	1 1/2	1 7/8 - 12	1 1/2	34.1	47.6	57.2	38.8	39.0
BLM 32T - 16N	2	2 1/2 - 12	2	46.0	63.5	75.0	49.7	49.9

\* ISO Tapered Threads are available upon request.

# SAE J514 Flareless Tube Fittings

## 45° Male Elbow

### BLMB

SAE 080302 MS51817

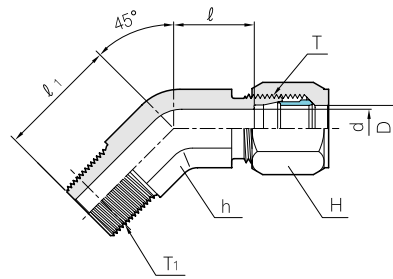

Part No.	Tube O.D D (in)	T Straight Thread Size	T <sub>1</sub> * NPT Size	d	Width across flat		l	l <sub>1</sub>
					h	H		
BLMB 3T - 01N	3/16	3/8 - 24	1/8	3.2	11.1	11.1	10.4	13.2
BLMB 4T - 01N	1/4	7/16 - 20	1/8	5.2	11.1	14.2	11.9	16.3
BLMB 4T - 02N	1/4	7/16 - 20	1/4	5.2	14.2	14.2	14.5	21.8
BLMB 5T - 01N	5/16	1/2 - 20	1/8	6.0	14.2	15.8	12.8	16.3
BLMB 6T - 02N	3/8	9/16 - 18	1/4	7.0	14.2	17.4	14.8	21.8
BLMB 8T - 03N	1/2	3/4 - 16	3/8	10.7	19.1	22.2	17.2	24.1
BLMB 10T - 04N	5/8	7/8 - 14	1/2	12.7	22.2	25.4	18.5	29.7
BLMB 12T - 06N	3/4	1 1/16 - 12	3/4	16.6	27.0	31.7	23.4	30.5
BLMB 14T - 06N	7/8	1 3/16 - 12	3/4	18.0	33.3	34.9	25.1	33.0
BLMB 16T - 08N	1	1 5/16 - 12	1	22.2	33.3	38.1	24.0	37.6
BLMB 20T - 10N	1 1/4	1 5/8 - 12	1 1/4	27.8	41.2	50.0	26.3	42.4

\* ISO Tapered Threads are available upon request.

## Male Run Tee

### BRTM

SAE 080424 MS51824

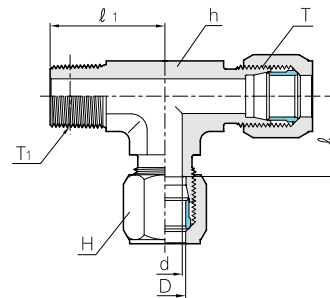

Part No.	Tube O.D D (in)	T Straight Thread Size	T <sub>1</sub> * NPT Size	d	Width across flat		l	l <sub>1</sub>
					h	H		
BRTM 4T - 01N	1/4	7/16 - 20	1/8	5.2	11.1	14.2	16.7	19.8
BRTM 4T - 02N	1/4	7/16 - 20	1/4	5.2	14.2	14.2	20.2	27.7
BRTM 5T - 01N	5/16	1/2 - 20	1/8	6.0	14.2	15.8	17.8	20.6
BRTM 6T - 02N	3/8	9/16 - 18	1/4	7.0	14.2	17.4	20.4	27.7
BRTM 8T - 03N	1/2	3/4 - 16	3/8	10.7	19.1	22.2	24.1	31.0
BRTM 8T - 04N	1/2	3/4 - 16	1/2	10.7	22.2	22.2	26.2	37.3
BRTM 10T - 04N	5/8	7/8 - 14	1/2	12.7	22.2	25.4	27.2	37.3
BRTM 12T - 06N	3/4	1 1/16 - 12	3/4	16.6	27.0	31.7	31.2	40.4
BRTM 14T - 06N	7/8	1 3/16 - 12	3/4	18.0	33.3	34.9	33.3	42.9
BRTM 16T - 08N	1	1 5/16 - 12	1	22.2	33.3	38.1	33.4	50.0

\* ISO Tapered Threads are available upon request.

All dimensions are in millimeters unless otherwise specified. Dimensions are for reference only, subject to change.

Male Branch Tee

**BBTM**

SAE 080425 MS51818

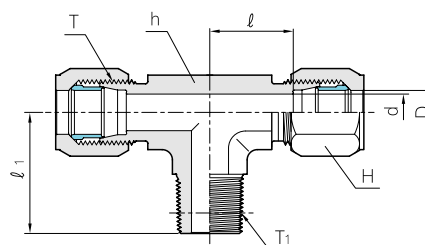

Part No.	Tube O.D D (in)	T Straight Thread Size	T <sub>1</sub> * NPT Size	d	Width across flat		ℓ	ℓ <sub>1</sub>
					h	H		
BBTM 2T - 01N	1/8	5/16 - 24	1/8	2.4	11.1	9.5	14.8	18.3
BBTM 4T - 01N	1/4	7/16 - 20	1/8	5.2	11.1	14.2	16.7	19.8
BBTM 4T - 02N	1/4	7/16 - 20	1/4	5.2	14.2	14.2	20.2	27.7
BBTM 5T - 01N	5/16	1/2 - 20	1/8	6.0	14.2	15.8	17.8	20.6
BBTM 6T - 02N	3/8	9/16 - 18	1/4	7.0	14.2	17.4	20.4	27.7
BBTM 8T - 03N	1/2	3/4 - 16	3/8	10.7	19.1	22.2	24.1	31.0
BBTM 8T - 04N	1/2	3/4 - 16	1/2	10.7	22.2	22.2	26.2	37.3
BBTM 10T - 04N	5/8	7/8 - 14	1/2	12.7	22.2	25.4	27.2	37.3
BBTM 12T - 06N	3/4	1 1/16 - 12	3/4	16.6	27.0	31.7	31.2	40.4
BBTM 14T - 06N	7/8	1 3/16 - 12	3/4	18.0	33.3	34.9	33.3	42.9
BBTM 16T - 08N	1	1 5/16 - 12	1	22.2	33.3	38.1	33.4	50.0

\* ISO Tapered Threads are available upon request.

O-ring Seal Male Connector

**BOM**

SAE 080120 MS51843

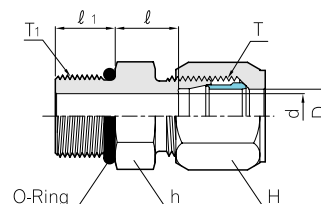

Part No.	Tube O.D D (in)	T Straight Thread Size	T <sub>1</sub> SAE/MS Straight Thread Size	d	Width across flat		ℓ	ℓ <sub>1</sub>
					h	H		
BOM 2T - 02U	1/8	5/16 - 24	5/16 - 24	2.4	11.1	9.5	12.8	7.5
BOM 3T - 03U	3/16	3/8 - 24	3/8 - 24	3.2	12.7	11.1	12.9	7.5
BOM 4T - 04U	1/4	7/16 - 20	7/16 - 20	5.2	14.2	14.2	13.6	9.1
BOM 5T - 05U	5/16	1/2 - 20	1/2 - 20	6.0	15.8	15.8	13.2	9.1
BOM 6T - 06U	3/8	9/16 - 18	9/16 - 18	7.0	17.4	17.4	14.4	9.9
BOM 8T - 08U	1/2	3/4 - 16	3/4 - 16	10.7	22.2	22.2	16.2	11.1
BOM 10T - 10U	5/8	7/8 - 14	7/8 - 14	12.7	25.4	25.4	18.3	12.7
BOM 12T - 12U	3/4	1 1/16 - 12	1 1/16 - 12	16.6	31.8	31.8	21.5	15.1
BOM 16T - 16U	1	1 5/16 - 12	1 5/16 - 12	22.2	38.1	38.1	20.6	15.1
BOM 20T - 20U	1 1/4	1 5/8 - 12	1 5/8 - 12	27.8	47.6	50.0	22.7	15.1
BOM 24T - 24U	1 1/2	1 7/8 - 12	1 7/8 - 12	34.1	54.0	57.2	22.6	15.1
BOM 32T - 32U	2	2 1/2 - 12	2 1/2 - 12	46.1	69.9	75.0	26.7	15.1

All dimensions are in millimeters unless otherwise specified. Dimensions are for reference only, subject to change.

## SAE J514 Flareless Tube Fittings

### O-ring Seal Male Elbow

#### BOLM

SAE 080220 MS51839

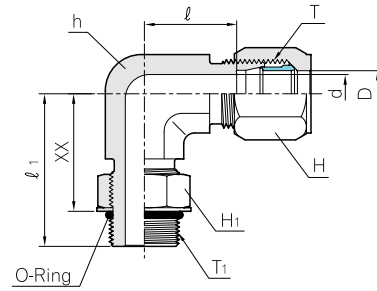

Part No.	Tube O.D D (in)	T Straight Thread Size	T <sub>1</sub> SAE/MS Straight Thread Size	d	Width across flat			l	l <sub>1</sub>	XX after ass'y
					h	H	H <sub>1</sub>			
BOLM 3T - 03U	3/16	3/8 - 24	3/8 - 24	3.2	11.1	11.1	12.7	15.2	23.9	16.3
BOLM 4T - 04U	1/4	7/16 - 20	7/16 - 20	5.2	11.1	14.2	14.2	16.7	26.2	17.0
BOLM 5T - 05U	5/16	1/2 - 20	1/2 - 20	6.0	14.2	15.8	15.8	17.8	28.7	19.6
BOLM 6T - 06U	3/8	9/16 - 18	9/16 - 18	7.0	14.2	17.4	17.4	20.4	31.8	21.8
BOLM 8T - 08U	1/2	3/4 - 16	3/4 - 16	10.7	19.1	22.2	22.2	24.1	36.8	25.7
BOLM 10T - 10U	5/8	7/8 - 14	7/8 - 14	12.7	22.2	25.4	25.4	27.2	43.2	30.5
BOLM 12T - 12U	3/4	1 1/16 - 12	1 1/16 - 12	16.6	27.0	31.7	31.7	31.2	49.3	34.3
BOLM 16T - 16U	1	1 5/16 - 12	1 5/16 - 12	22.2	33.3	38.1	38.1	33.3	52.1	37.1
BOLM 20T - 20U	1 1/4	1 5/8 - 12	1 5/8 - 12	27.8	41.2	50.0	47.6	42.3	57.2	42.2
BOLM 24T - 24U	1 1/2	1 7/8 - 12	1 7/8 - 12	34.1	47.6	57.2	54.0	52.2	60.7	45.7
BOLM 32T - 32U	2	2 1/2 - 12	2 1/2 - 12	46.0	63.5	75.0	70.0	54.8	73.4	56.6

### O-Ring Seal 45° Male Elbow

#### BOLMB

SAE 080320 MS51842

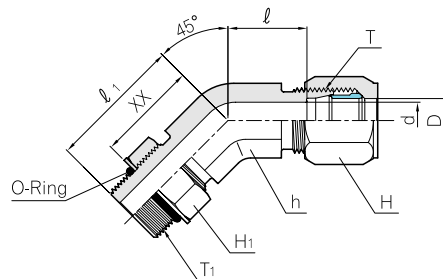

Part No.	Tube O.D D (in)	T Straight Thread Size	T <sub>1</sub> SAE/MS Straight Thread Size	d	Width across flat			l	l <sub>1</sub>	XX after ass'y
					h	H	H <sub>1</sub>			
BHBM 4T-04U	1/4	7/16 - 20	7/16 - 20	5.2	11.1	14.2	14.2	11.7	26.7	17.6
BHBM 6T-06U	3/8	9/16 - 18	9/16 - 18	7.0	14.2	17.4	17.4	14.6	29.0	19.1
BHBM 8T-08U	1/2	3/4 - 16	3/4 - 16	10.7	19.1	22.2	22.2	17.2	33.0	21.8
BHBM12T-12U	3/4	1 1/16 - 12	1 1/16 - 12	16.6	27.0	31.7	31.7	23.4	43.9	28.9
BHBM16T-16U	1	1 5/16 - 12	1 5/16 - 12	22.2	33.3	38.1	38.1	24.0	47.2	32.2

All dimensions are in millimeters unless otherwise specified. Dimensions are for reference only, subject to change.

O-ring Seal Run Tee

**BORTM**

SAE 080428 MS51892

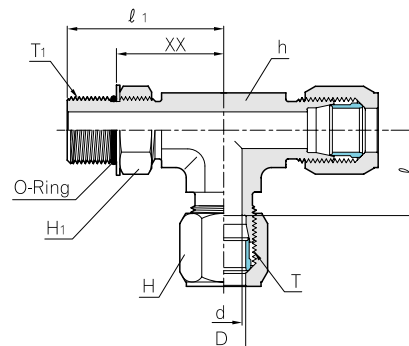

Part No.	Tube O.D D (in)	T Straight Thread Size	T <sub>1</sub> SAE/MS Straight Thread Size	d	Width across flat			ℓ	ℓ <sub>1</sub>
					h	H	H <sub>1</sub>		
BORTM 4T-04U	1/4	7/16 - 20	7/16 - 20	5.2	11.1	14.2	14.2	16.7	26.2
BORTM 6T-06U	3/8	9/16 - 18	9/16 - 18	7.0	14.2	17.4	17.4	22.4	31.8
BORTM 8T-08U	1/2	3/4 - 16	3/4 - 16	10.7	19.1	22.2	22.2	24.1	36.8
BORTM10T-10U	5/8	7/8 - 14	7/8 - 14	12.7	22.2	25.4	25.4	27.2	43.2
BORTM12T-12U	3/4	1 1/16 - 12	1 1/16 - 12	16.6	27.0	31.7	31.7	31.2	49.3
BORTM16T-16U	1	1 5/16 - 12	1 5/16 - 12	22.2	33.3	38.1	38.1	33.4	52.1

O-ring Seal Branch Tee

**BORTM**

SAE 080429 MS51841

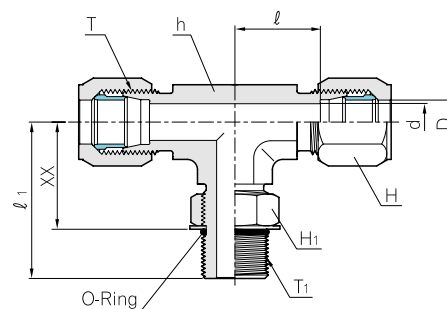

Part No.	Tube O.D D (in)	T Straight Thread Size	T <sub>1</sub> SAE/MS Straight Thread Size	d	Width across flat			ℓ	ℓ <sub>1</sub>	XX after ass'y
					h	H	H <sub>1</sub>			
BOLM 4T-04U	1/4	7/16 - 20	7/16 - 20	5.2	11.1	14.2	14.2	16.7	26.2	17.0
BOLM 6T-06U	3/8	9/16 - 18	9/16 - 18	7.0	14.2	17.4	17.4	22.4	31.8	21.8
BOLM 8T-08U	1/2	3/4 - 16	3/4 - 16	10.7	19.1	22.2	22.2	24.1	36.8	25.7
BOLM12T-12U	3/4	1 1/16 - 12	1 1/16 - 12	16.6	27.0	31.7	31.7	31.2	49.3	34.3
BOLM16T-16U	1	1 5/16 - 12	1 5/16 - 12	22.2	33.3	38.1	38.1	33.4	52.1	37.1

All dimensions are in millimeters unless otherwise specified. Dimensions are for reference only, subject to change.

# SAE J514 Flareless Tube Fittings

## O-ring Seal Long Male Elbow BOLLM

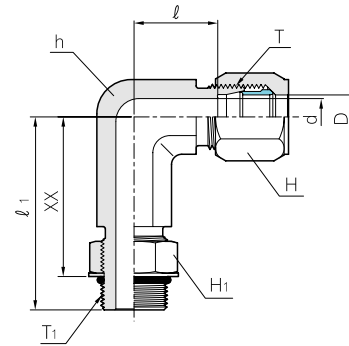

Part No.	Tube O.D D (in)	T Straight Thread Size	T <sub>1</sub> SAE/MS Straight Thread Size	d	Width across flat			l	l <sub>1</sub>	XX after ass'y
					h	H	H <sub>1</sub>			
BOLLM 4T-04U	1/4	7/16 - 20	7/16 - 20	5.2	11.1	14.2	14.2	16.7	36.3	27.2
BOLLM 6T-06U	3/8	9/16 - 18	9/16 - 18	7.0	14.2	17.4	17.4	20.4	43.7	33.8
BOLLM 8T-08U	1/2	3/4 - 16	3/4 - 16	10.7	19.1	22.2	22.2	24.1	51.3	40.1
BOLLM10T-10U	5/8	7/8 - 14	7/8 - 14	12.7	22.2	25.4	25.4	27.2	60.7	48.0
BOLLM12T-12U	3/4	1 1/16 - 12	1 1/16 - 12	16.6	27.0	31.7	31.7	31.2	68.3	53.3
BOLLM16T-16U	1	1 5/16 - 12	1 5/16 - 12	22.2	33.3	38.1	38.1	33.4	79.5	64.5

## Swivel Elbow BSL

SAE 080221 MS51852

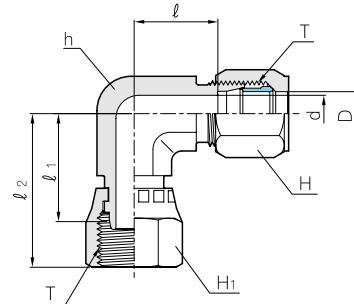

l<sub>2</sub> - Center to end of Mating Part

Part No.	Tube O.D D (in)	T Straight Thread Size	d	Width across flat			l	l <sub>1</sub>	l <sub>2</sub>
				h	H	H <sub>1</sub>			
BSL - 4T	1/4	7/16 - 20	5.2	11.1	14.2	14.2	16.6	19.1	26.7
BSL - 6T	3/8	9/16 - 18	7.0	14.2	17.4	17.4	20.4	23.9	32.5
BSL - 8T	1/2	3/4 - 16	10.7	19.1	22.2	22.2	24.1	27.2	37.3
BSL - 10T	5/8	7/8 - 14	12.7	22.2	25.4	25.4	27.2	30.5	40.9
BSL - 12T	3/4	1 1/16 - 12	16.6	27.0	31.7	31.7	31.2	32.8	45.0
BSL - 16T	1	1 5/16 - 12	22.2	33.3	38.1	38.1	33.4	36.3	47.2
BSL - 20T	1 1/4	1 5/8 - 12	27.8	41.3	50.8	50.8	42.3	42.2	52.8

All dimensions are in millimeters unless otherwise specified. Dimensions are for reference only, subject to change.

## Swivel Run Tee

**BSRT**

SAE 080432 MS51854

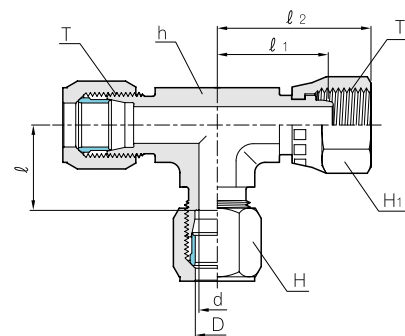
 $l_1$  - Center to end of Mating Part

Part No.	Tube O.D D (in)	T Straight Thread Size	d	Width across flat			l	l <sub>1</sub>	l <sub>2</sub>
				h	H	H <sub>1</sub>			
BSRT - 4T	1/4	7/16 - 20	5.2	11.1	14.2	14.2	16.6	19.1	26.7
BSRT - 6T	3/8	9/16 - 18	7.0	14.2	17.4	17.4	20.4	23.9	32.5
BSRT - 8T	1/2	3/4 - 16	10.7	19.1	22.2	22.2	24.1	27.2	37.3
BSRT - 12T	3/4	1 1/16 - 12	16.6	27.0	31.7	31.7	31.2	32.8	45.0
BSRT - 16T	1	1 5/16 - 12	22.2	33.3	38.1	38.1	33.4	36.3	47.2

## Swivel Branch Tee

**BSBT**

SAE 080433 MS51853

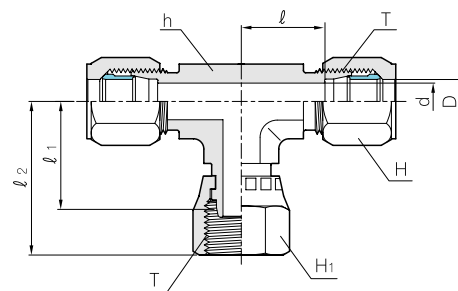
 $l_1$  - Center to end of Mating Part

Part No.	Tube O.D D (in)	T Straight Thread Size	d	Width across flat			l	l <sub>1</sub>	l <sub>2</sub>
				h	H	H <sub>1</sub>			
BSBT - 4T	1/4	7/16 - 20	5.2	11.1	14.2	14.2	16.6	19.1	26.7
BSBT - 6T	3/8	9/16 - 18	7.0	14.2	17.4	17.4	20.4	23.9	32.5
BSBT - 8T	1/2	3/4 - 16	10.7	19.1	22.2	22.2	24.1	27.2	37.3
BSBT - 12T	3/4	1 1/16 - 12	16.6	27.0	31.7	31.7	31.2	32.8	45.0

## SAE J514 Flareless Tube Fittings

### Female Connector

### BFC

SAE 080103 MS51816

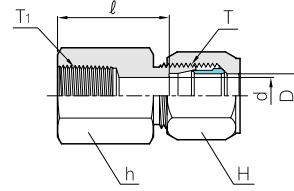

Part No.	Tube O.D D (in)	T Straight Thread Size	T <sub>1</sub> * NPT Size	d	Width across flat		ℓ
					h	H	
BFC 2T - 01N	1/8	5/16 - 24	1/8	2.4	14.2	9.5	21.9
BFC 4T - 01N	1/4	7/16 - 20	1/8	5.2	14.2	14.2	21.8
BFC 4T - 02N	1/4	7/16 - 20	1/4	5.2	19.1	14.2	26.7
BFC 5T - 01N	5/16	1/2 - 20	1/8	6.0	14.2	15.8	21.1
BFC 6T - 02N	3/8	9/16 - 18	1/4	7.0	19.1	17.4	27.0
BFC 6T - 03N	3/8	9/16 - 18	3/8	7.0	22.2	17.4	27.7
BFC 6T - 04N	3/8	9/16 - 18	1/2	7.0	28.5	17.4	34.0
BFC 8T - 02N	1/2	3/4 - 16	1/4	10.7	22.2	22.2	29.3
BFC 8T - 03N	1/2	3/4 - 16	3/8	10.7	22.2	22.2	29.6
BFC 8T - 04N	1/2	3/4 - 16	1/2	10.7	28.5	22.2	35.2
BFC 10T - 04N	5/8	7/8 - 14	1/2	12.7	28.5	25.4	35.8
BFC 12T - 06N	3/4	1 1/16 - 12	3/4	16.6	34.9	31.7	39.1
BFC 14T - 06N	7/8	1 3/16 - 12	3/4	18.0	34.9	34.9	38.3
BFC 16T - 08N	1	1 5/16 - 12	1	22.2	41.2	38.1	43.6
BFC 20T - 10N	1 1/4	1 5/8 - 12	1 1/4	27.8	50.0	50.0	45.9
BFC 24T - 12N	1 1/2	1 7/8 - 12	1 1/2	34.1	60.0	57.2	44.3

\* ISO Tapered Threads are available upon request.

### Female Elbow

### BLF

SAE 080203 MS51813

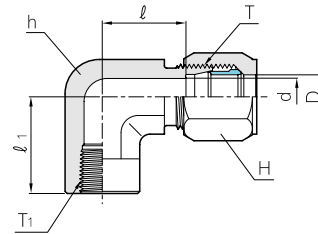

Part No.	Tube O.D D (in)	T Straight Thread Size	T <sub>1</sub> * NPT Size	d	Width across flat		ℓ	ℓ <sub>1</sub>
					h	H		
BLF 4T - 01N	1/4	7/16 - 20	1/8	5.2	14.2	14.2	16.7	16.8
BLF 4T - 02N	1/4	7/16 - 20	1/4	5.2	19.1	14.2	20.2	22.4
BLF 5T - 01N	5/16	1/2 - 20	1/8	6.0	14.2	15.8	17.8	16.8
BLF 6T - 02N	3/8	9/16 - 18	1/4	7.0	19.1	17.4	20.4	22.4
BLF 6T - 03N	3/8	9/16 - 18	3/8	7.0	22.2	17.4	22.4	25.9
BLF 8T - 02N	1/2	3/4 - 16	1/4	10.7	19.1	22.2	23.5	22.4
BLF 8T - 03N	1/2	3/4 - 16	3/8	10.7	22.2	22.2	23.5	25.9
BLF 8T - 04N	1/2	3/4 - 16	1/2	10.7	27.0	22.2	26.3	31.2
BLF 10T - 04N	5/8	7/8 - 14	1/2	12.7	27.0	25.4	27.2	31.2
BLF 12T - 06N	3/4	1 1/16 - 12	3/4	16.6	33.3	31.7	31.2	34.5
BLF 14T - 06N	7/8	1 3/16 - 12	3/4	18.0	33.3	34.9	32.2	36.1
BLF 16T - 08N	1	1 5/16 - 12	1	22.2	41.2	38.1	33.4	41.1
BLF 20T - 10N	1 1/4	1 5/8 - 12	1 1/4	27.8	47.6	50.0	42.3	43.2
BLF 24T - 12N	1 1/2	1 7/8 - 12	1 1/2	34.1	63.5	57.2	53.2	52.8

\* ISO Tapered Threads are available upon request.

All dimensions are in millimeters unless otherwise specified. Dimensions are for reference only, subject to change.

Female Run Tee

**BRTF**

SAE 080426 MS51822

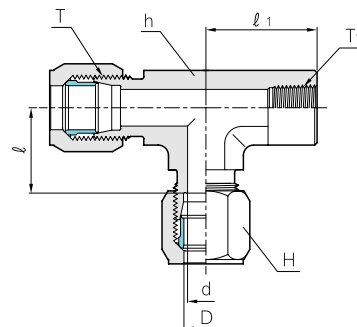

Part No.	Tube O.D D (in)	T Straight Thread Size	T <sub>1</sub> * NPT Size	d	Width across flat		l	l <sub>1</sub>
					h	H		
BRTF 4T - 01N	1/4	7/16 - 20	1/8	5.2	14.2	14.2	16.6	16.8
BRTF 6T - 02N	3/8	9/16 - 18	1/4	7.0	19.1	17.4	20.4	22.4
BRTF 8T - 03N	1/2	3/4 - 16	3/8	10.7	22.2	22.2	23.5	25.9
BRTF 10T - 04N	5/8	7/8 - 14	1/2	12.7	27.0	25.4	27.2	31.2
BRTF 12T - 06N	3/4	1 1/16 - 12	3/4	16.6	33.3	31.7	31.2	34.5
BRTF 16T - 08N	1	1 5/16 - 12	1	22.2	41.2	38.1	33.4	41.4

\* ISO Tapered Threads are available upon request.

Female Branch Tee

**BBTF**

SAE 080427 MS51821

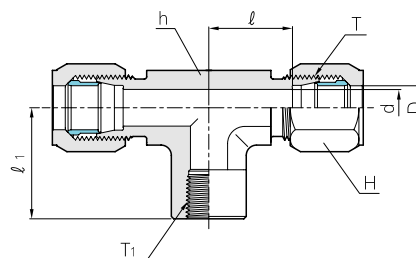

Part No.	Tube O.D D (in)	T Straight Thread Size	T <sub>1</sub> * NPT Size	d	Width across flat		l	l <sub>1</sub>
					h	H		
BBTF 4T - 01N	1/4	7/16 - 20	1/8	5.2	14.2	14.2	16.6	16.8
BBTF 4T - 02N	1/4	7/16 - 20	1/4	5.2	19.1	14.2	20.2	22.4
BBTF 6T - 02N	3/8	9/16 - 18	1/4	7.0	19.1	17.4	20.4	22.4
BBTF 8T - 03N	1/2	3/4 - 16	3/8	10.7	22.2	22.2	23.5	25.9
BBTF 10T - 04N	5/8	7/8 - 14	1/2	12.7	27.0	25.4	27.2	31.2
BBTF 12T - 06N	3/4	1 1/16 - 12	3/4	16.6	33.3	31.7	31.2	34.5
BBTF 14T - 06N	7/8	1 3/16 - 12	3/4	18.0	33.3	34.9	32.2	36.1
BBTF 16T - 08N	1	1 5/16 - 12	1	22.2	41.2	38.1	33.4	41.1
BBTF 20T - 10N	1 1/4	1 5/8 - 12	1 1/4	27.8	47.6	50.0	42.3	43.2

\* ISO Tapered Threads are available upon request.

All dimensions are in millimeters unless otherwise specified. Dimensions are for reference only, subject to change.

# SAE J514 Flareless Tube Fittings

## Hose Male Union BHUM

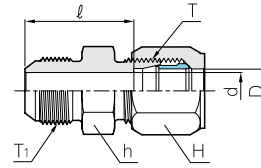

Part No.	Tube O.D D (in)	T Straight Thread Size	T <sub>1</sub> Straight Thread Size	d	Width across flat		l
					h	H	
BHUM 4T - 04U	1/4	7/16 - 20	7/16 - 20	4.4	12.7	14.2	24.1
BHUM 6T - 06U	3/8	9/16 - 18	9/16 - 18	7.5	15.8	17.4	25.9
BHUM 8T - 08U	1/2	3/4 - 16	3/4 - 16	9.9	20.6	22.2	29.4
BHUM 10T - 10U	5/8	7/8 - 14	7/8 - 14	12.3	23.8	25.4	33.8
BHUM 12T - 12U	3/4	1 1/16 - 12	1 1/16 - 12	15.5	28.5	31.7	40.1
BHUM 16T - 16U	1	1 5/16 - 12	1 5/16 - 12	21.4	41.2	38.1	39.4
BHUM 20T - 20U	1 1/4	1 5/8 - 12	1 5/8 - 12	27.6	44.4	50.0	40.1
BHUM 24T - 24U	1 1/2	1 7/8 - 12	1 7/8 - 12	33.3	54.0	75.0	42.4

## Hose Bulkhead Male Union BHBM

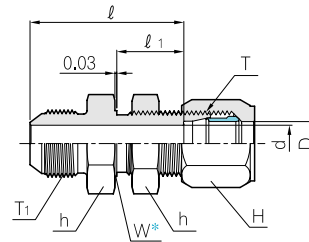

W\* - Bulkhead Pilot Dia.  
Recommended Clearance  
Hole +0.015 Over W Dia

Part No.	Tube O.D D (in)	T Straight Thread Size	T <sub>1</sub> Straight Thread Size	d	Width across flat		l	l <sub>1</sub>	W	Max. Bulkhead Thickness
					h	H				
BHBM 4T - 04U	1/4	7/16 - 20	7/16 - 20	4.4	17.4	14.2	43.2	22.6	11.2	9.7
BHBM 6T - 06U	3/8	9/16 - 18	9/16 - 18	7.5	20.6	17.4	46.2	23.1	14.2	10.2
BHBM 8T - 08U	1/2	3/4 - 16	3/4 - 16	9.9	25.4	22.2	50.8	25.4	19.1	10.2
BHBM 10T - 10U	5/8	7/8 - 14	7/8 - 14	12.3	28.5	25.4	55.9	27.7	22.4	9.4
BHBM 12T - 12U	3/4	1 1/16 - 12	1 1/16 - 12	15.5	34.9	31.7	65.6	30.5	26.9	10.9
BHBM 16T - 16U	1	1 5/16 - 12	1 5/16 - 12	21.4	41.2	38.1	64.2	28.9	33.3	10.9

All dimensions are in millimeters unless otherwise specified. Dimensions are for reference only, subject to change.

## Reducer

**BR**

SAE 080123

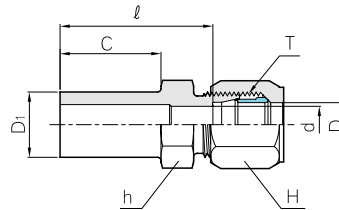

Part No.	Tube O.D D <sub>1</sub> x D	T Straight Thread Size	d	Width across flat		C	ℓ
				h	H		
BR 6T x 4T	3/8 to 1/4	7/16 - 20	5.2	12.7	14.2	22.4	35.0
BR 8T x 4T	1/2 to 1/4	7/16 - 20	5.2	14.3	14.2	25.4	38.0
BR 8T x 6T	1/2 to 3/8	9/16 - 18	7.0	15.9	17.4	25.4	38.7
BR 10T x 6T	5/8 to 3/8	9/16 - 18	7.0	17.4	17.4	27.7	40.9
BR 10T x 8T	5/8 to 1/2	3/4 - 16	10.7	20.6	22.2	27.7	42.1
BR 12T x 6T	3/4 to 3/8	9/16 - 18	7.0	20.6	17.4	29.5	42.7
BR 12T x 8T	3/4 to 1/2	3/4 - 16	10.7	20.6	22.2	29.5	43.9
BR 12T x 10T	3/4 to 5/8	7/8 - 14	12.7	23.8	25.4	29.5	45.7
BR 14T x 10T	7/8 to 5/8	7/8 - 14	12.7	23.8	25.4	29.5	45.5
BR 16T x 8T	1 to 1/2	3/4 - 16	10.7	27.0	22.2	28.4	44.4
BR 16T x 10T	1 to 5/8	7/8 - 14	12.7	27.0	25.4	28.4	44.7
BR 16T x 12T	1 to 3/4	1 1/16 - 12	16.6	28.6	31.8	28.4	48.0
BR 20T x 16T	1 1/4 to 1	1 5/16 - 12	22.2	34.9	38.1	29.5	47.4
BR 24T x 12T	1 1/2 to 3/4	1 1/16 - 12	16.6	41.3	31.8	31.8	53.3
BR 24T x 16T	1 1/2 to 1	1 5/16 - 12	22.2	41.3	38.1	31.8	51.7
BR 12T x 8T	1 1/2 to 1 1/4	1 5/8 - 12	27.8	47.6	50.0	31.8	51.7

All dimensions are in millimeters unless otherwise specified. Dimensions are for reference only, subject to change.

## SAE J514 Flareless Tube Fittings

### Plug

### BP

SAE 080112 MS51890

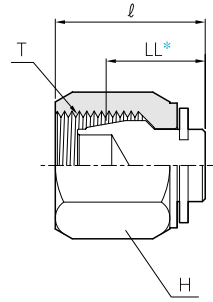

LL\* - Fitting end to Rear of Plug

Part No.	Tube O.D D (in)	T Straight Thread Size	Width across flat		LL	l
			H			
BP - 2T	1/8	5/16 - 24	9.5		8.6	14.0
BP - 4T	1/4	7/16 - 20	14.2		9.1	18.5
BP - 5T	5/16	1/2 - 20	15.8		10.2	19.6
BP - 6T	3/8	9/16 - 18	17.4		10.7	20.3
BP - 8T	1/2	3/4 - 16	22.2		11.2	22.1
BP - 10T	5/8	7/8 - 14	25.4		11.9	24.9
BP - 12T	3/4	1 1/16 - 12	31.7		12.2	25.4
BP - 16T	1	1 5/16 - 12	38.1		14.7	27.4
BP - 20T	1 1/4	1 5/8 - 12	50.0		16.3	28.2

### Cap

### BCA

SAE 080109 MS51891

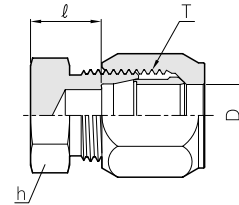

Part No.	Tube O.D D (in)	T Straight Thread Size	Width across flat		l
			h		
BCA - 2T	1/8	5/16 - 24	11.1		11.2
BCA - 4T	1/4	7/16 - 20	12.7		12.1
BCA - 5T	5/16	1/2 - 20	14.2		11.7
BCA - 6T	3/8	9/16 - 18	15.8		12.7
BCA - 8T	1/2	3/4 - 16	20.6		13.9
BCA - 10T	5/8	7/8 - 14	23.8		15.7
BCA - 12T	3/4	1 1/16 - 12	28.5		19.0
BCA - 16T	1	1 5/16 - 12	34.9		17.4

All dimensions are in millimeters unless otherwise specified. Dimensions are for reference only, subject to change.

Nut

**BN**

SAE 080110 MS51823

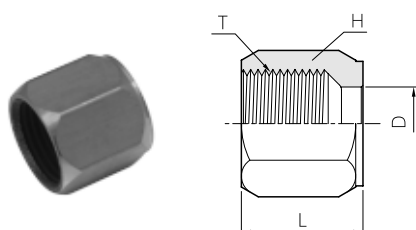

Sleeve

**BS**

SAE 080115B

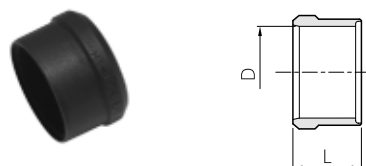

Part No.	Tube O.D D (in)	T Straight Thread Size	Width across flat		L
			H		
BN - 2T	1/8	5/16 - 24	9.5		13.5
BN - 3T	3/16	3/8 - 24	11.1		15.5
BN - 4T	1/4	7/16 - 20	14.2		17.8
BN - 5T	5/16	1/2 - 20	15.8		18.3
BN - 6T	3/8	9/16 - 18	17.4		19.1
BN - 8T	1/2	3/4 - 16	22.2		21.3
BN - 10T	5/8	7/8 - 14	25.4		23.4
BN - 12T	3/4	1 1/16 - 12	31.8		24.6
BN - 14T	7/8	1 3/16 - 12	34.9		25.4
BN - 16T	1	1 5/16 - 12	38.1		26.7
BN - 20T	1 1/4	1 5/8 - 12	50.0		26.7
BN - 24T	1 1/2	1 7/8 - 12	57.2		26.2
BN - 32T	2	2 1/2 - 12	75.0		28.4

Part No.	Tube O.D D (in)	L
BS - 2T	1/8	7.1
BS - 3T	3/16	7.1
BS - 4T	1/4	8.6
BS - 5T	5/16	8.6
BS - 6T	3/8	9.6
BS - 8T	1/2	9.6
BS - 10T	5/8	10.6
BS - 12T	3/4	10.6
BS - 14T	7/8	10.6
BS - 16T	1	10.6
BS - 20T	1 1/4	10.6
BS - 24T	1 1/2	10.6
BS - 32T	2	11.6

Bulkhead Union Elbow

**BBL**

SAE 080701 MS51855

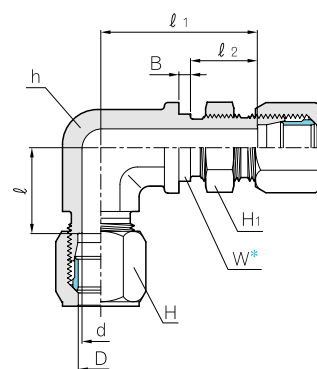

W\* - Bulkhead Pilot Dia.

Part No.	Tube O.D D (in)	T Straight Thread Size	d	Width across flat			B	l	l <sub>1</sub>	l <sub>2</sub>	W	Max. Bulkhead Thickness
				h	H	H <sub>1</sub>						
BBL - 6T	3/8	9/16 - 18	7.0	14.3	17.4	20.6	2.4	21.1	36.9	18.6	14.5	6.6
BBL - 8T	1/2	3/4 - 16	10.7	19.1	22.2	25.4	3.2	26.1	42.3	20.7	18.9	7.6

All dimensions are in millimeters unless otherwise specified. Dimensions are for reference only, subject to change.



Distributed by :