

HYDRAULIC

HOSE FITTINGS

Catalog No. H-400HF
Jul. 2023



HY-LOK CORPORATION

© 2000-2023 HY-LOK CORPORATION All rights reserved



General Informations

■ PART NUMBER DESIGNATIONS

H
M
C
M
-
0
2
0
2
R
/
S
T
E
L

1
2
3
4
5
6
7
8

1 Fitting Symbols

H : Hose Adapter HO : Straight Thread O-Ring Boss HS : Swivel Hose BH : Bite Type HP : Paint Shop(Optional)

2 Hose Connection Seat Symbols

M : Male Flare F : Female Flare

3 Shape Symbols

A : 90° Elbow B : 45° Elbow C : Straight connector U : Union

4 End Connection Symbols

M : Male Thread F : Female Thread

5 Hose Connection Thread Size Symbols

| Nom. Size | G (PF) 1/8 | G (PF) 1/4 | G (PF) 3/8 | G (PF) 1/2 | G (PF) 3/4 | G (PF) 1 |
|------------|------------|------------|------------|------------|------------|----------|
| Identifier | 01 | 02 | 03 | 04 | 06 | 08 |

6 Boss & Port Thread Size Symbols

Pipe Thread

| Nom. Size | 1/8 | 1/4 | 3/8 | 1/2 | 3/4 | 1 |
|------------|-----|-----|-----|-----|-----|----|
| Identifier | 01 | 02 | 03 | 04 | 06 | 08 |

Straight(unified) Thread

| Nom. Size | 7/16-20 | 1/2-20 | 9/16-18 | 3/4-16 | 7/8-14 | 1 1/16-12 | 1 3/16-12 | 1 5/16-12 | 1 5/8-12 |
|------------|---------|--------|---------|--------|--------|-----------|-----------|-----------|----------|
| Identifier | 04 | 05 | 06 | 08 | 10 | 12 | 14 | 16 | 20 |

7 Thread Symbols

| Type | Symbol | Specification |
|------------------|--------|---|
| Taper Threads | R | JIS B 0203(PT), DIN2999, ISO 7/1, BS21(BSP TR.) |
| | N | ANSI B1.20.1(NPT) |
| Parallel Threads | G | JIS B 0202(PF), ISO 228/1, BS 2779(BSP PL.) |
| | U | American Standard Unified Screw Threads |

8 Material Symbols

| Materials | Carbon Steel | S. Steel 316 | Brass |
|------------|--------------|--------------|-------|
| Identifier | STEL | S 316 | BRAS |

■ SPECIFICATIONS

- Working Pressure : Max. 315Kgf / cm²
- Temperature Range : -30℃ ~ +100℃
- Applicable Fluid : General Hydraulic Oil
- Fitting Materials : Body & Nut : Carbon Steel (KS D3526, D3752, JIS G3108, G4051)
Stainless Steel(KS D3706, JIS G4303)

* O-Ring :

| Material | Temperature Range |
|---------------------|-------------------|
| NBR(Standard Spec.) | -30℃ ~ +100℃ |
| VITON | -30℃ ~ +180℃ |

* O-Ring will be available only when you specify it.

■ HOW TO ORDER



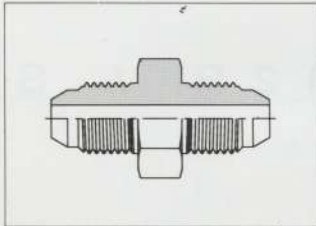
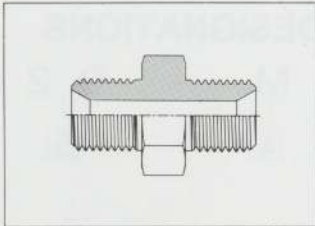
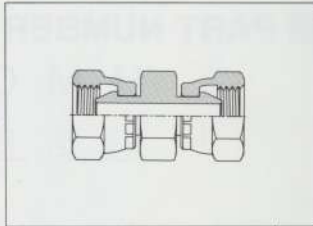
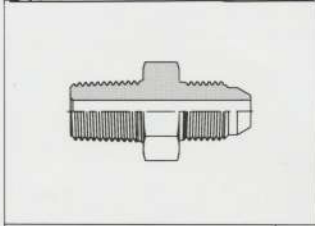
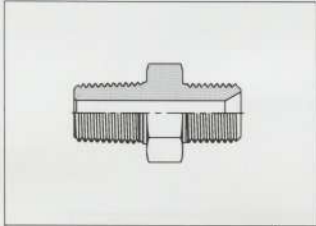
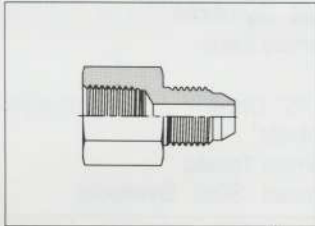
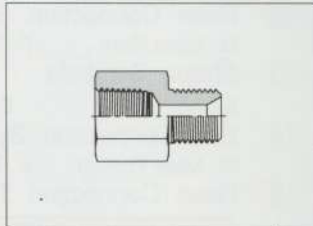
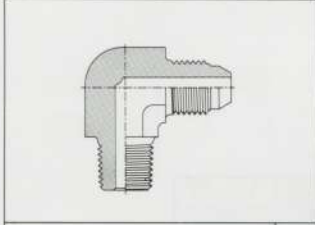
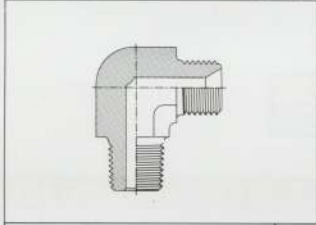
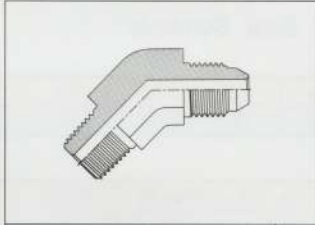
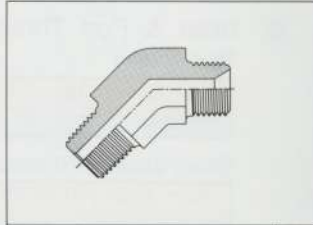
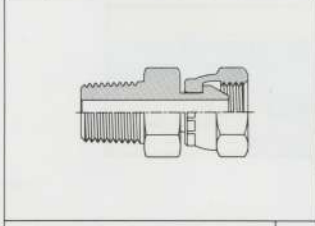
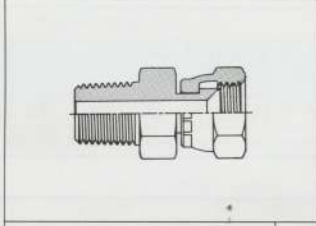
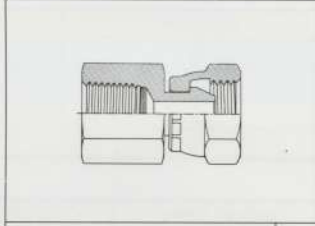
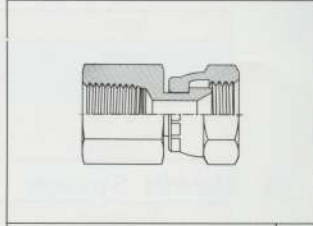
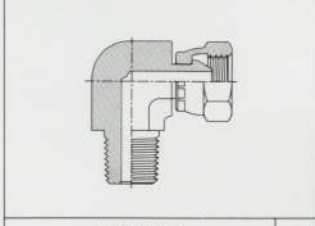
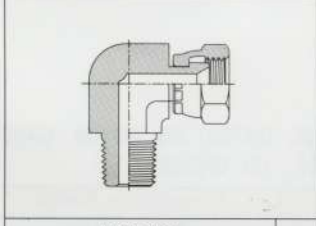
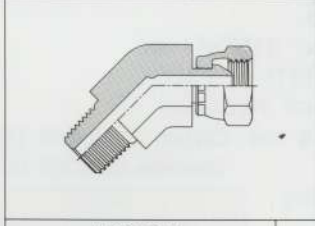
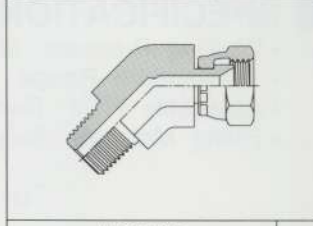
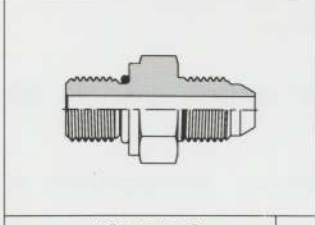
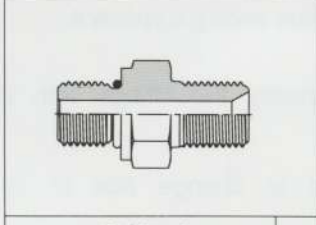
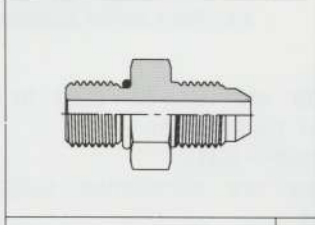
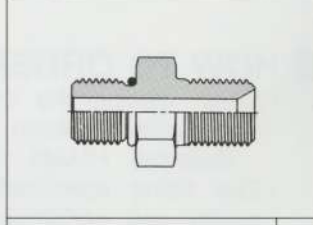

- When placing the order with us, be sure to specify the fittings with their symbols given in the part number column on each page.
Example : HMAM - 0202R - S316
- The fitting specifications are sometimes subject to change due to continuous improvements of quality and performance
- If there is any possibility of question as to the fitting desired, particularly for special fitting configurations, it is suggested that a sketch be submitted with the fitting order.

Visual Index

High Pressure
for
210Kgf/cm²

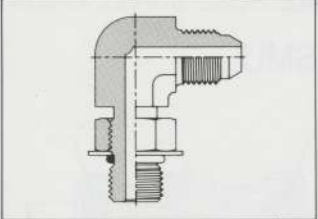
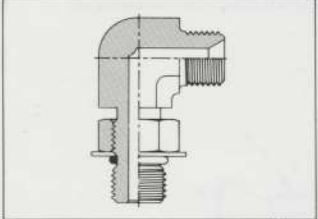
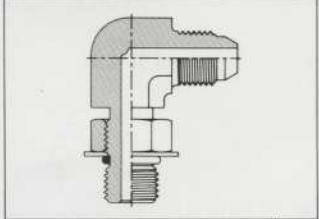
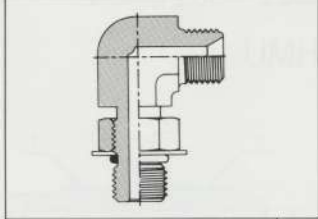
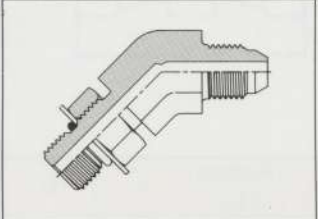
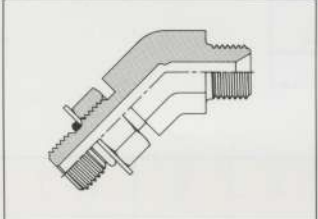
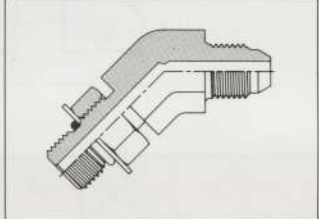
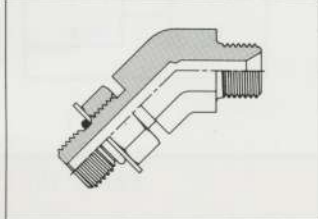
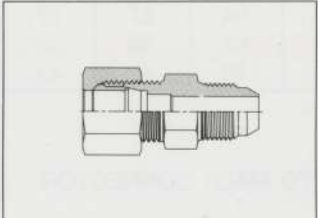
| | | | |
|---|---|--|---|
|  |  |  | |
| HMU 4 | HFU 4 | HSMU 4 | |
|  |  |  |  |
| HMCM 4 | HFCM 4 | HMCF 5 | HFCF 5 |
|  |  |  |  |
| HMAM 5 | HFAM 5 | HMBM 6 | HFBM 6 |
|  |  |  |  |
| HSMCM 6 | HSFCM 6 | HSMCF 7 | HSFCF 7 |
|  |  |  |  |
| HSMAM 7 | HSFAM 7 | HSMBM 8 | HSFBM 8 |
|  |  |  |  |
| HOMCM-G 8 | HOFCM-G 8 | HOMCM-U 9 | HOFCM-U 9 |

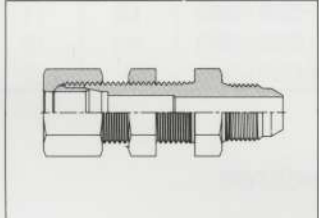
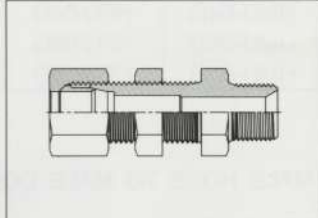
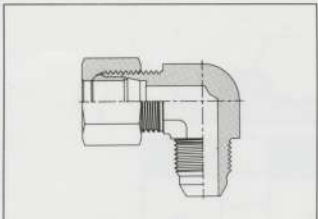
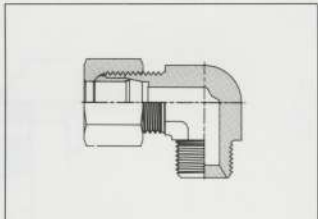
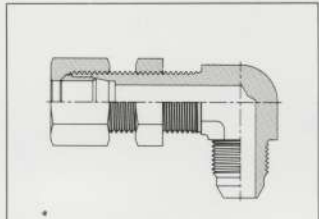
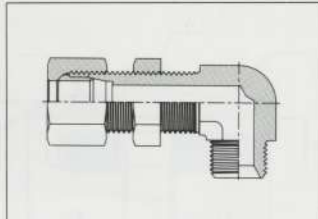
Visual Index

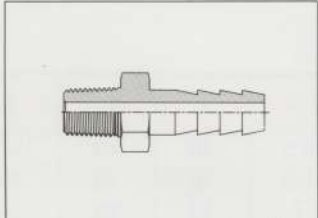
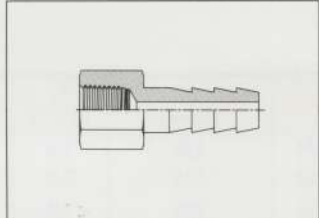
| | | | |
|---|---|--|---|
|  |  |  |  |
| HOMAM-G 10 | HOFAM-G 10 | HOMAM-U 10 | HOFAM-U 10 |
|  |  |  |  |
| HOMBM-G 11 | HOFBM-G 11 | HOMBM-U 11 | HOFBM-U 11 |
|  |  |  |  |
| BHUM 12 | BHUF 12 | BHBM 13 | BHBF 13 |
|  |  |  |  |
| BHLM 14 | BHLF 14 | BHBLM 15 | BHBLF 15 |
|  |  |  | |
| | HNM 16 | HNF 16 | |

Hydraulic Hose Fittings

MALE HOSE UNION

HMU

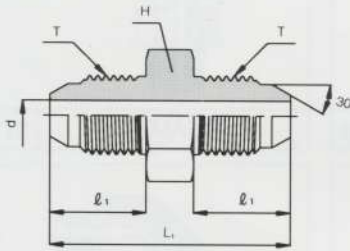

FEMALE HOSE UNION

HFU

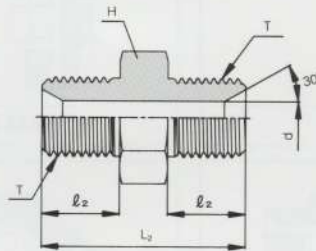

MALE HOSE SWIVEL UNION

HSMU

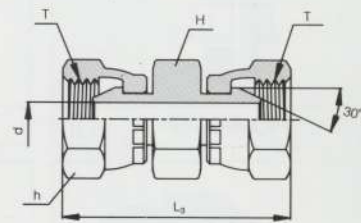

| PART No. | | | T G(PF) | d | l ₁ | l ₂ | L ₁ | L ₂ | Approx L ₃ | h | H |
|----------|---------|----------|------------|-----|----------------|----------------|----------------|----------------|--------------------------|----|----|
| HMU-02G | HFU-02G | HSMU-02G | 1/4 | 5.5 | 16 | 13 | 40 | 34 | 38 | 19 | 19 |
| HMU-03G | HFU-03G | HSMU-03G | 3/8 | 8 | 18 | 15 | 44 | 38 | 48 | 22 | 22 |
| HMU-04G | HFU-04G | HSMU-04G | 1/2 | 11 | 20 | 18 | 50 | 46 | 54 | 27 | 27 |
| HMU-06G | HFU-06G | HSMU-06G | 3/4 | 16 | 22 | 20 | 56 | 52 | 64 | 36 | 36 |
| HMU-08G | HFU-08G | HSMU-08G | 1 | 22 | 23 | 22 | 59 | 57 | 70 | 41 | 41 |

MALE HOSE TO MALE CONNECTOR

HMCM

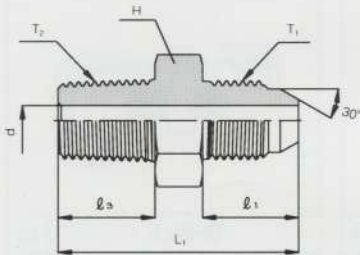

FEMALE HOSE TO MALE CONNECTOR

HFCM

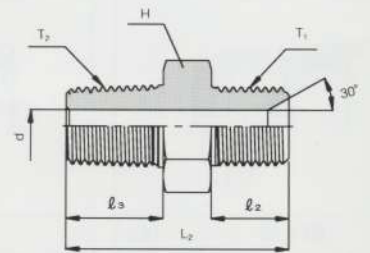

| PART No. | | T ₁ G(PF) | T ₂ R(PT) | d | l ₁ | l ₂ | l ₃ | L ₁ | L ₂ | H |
|------------|------------|-------------------------|-------------------------|-----|----------------|----------------|----------------|----------------|----------------|----|
| HMCM-0202R | HFCM-0202R | 1/4 | 1/4 | 5.5 | 16 | 13 | 14 | 37 | 34 | 19 |
| HMCM-0203R | HFCM-0203R | 1/4 | 3/8 | 5.5 | 16 | 13 | 15 | 39 | 35 | 19 |
| HMCM-0302R | HFCM-0302R | 3/8 | 1/4 | 7 | 18 | 15 | 14 | 40 | 37 | 22 |
| HMCM-0303R | HFCM-0303R | 3/8 | 3/8 | 8 | 18 | 15 | 15 | 41 | 38 | 22 |
| HMCM-0304R | HFCM-0304R | 3/8 | 1/2 | 8 | 18 | 15 | 19 | 45 | 42 | 22 |
| HMCM-0403R | HFCM-0403R | 1/2 | 3/8 | 9 | 20 | 18 | 15 | 44 | 42 | 27 |
| HMCM-0404R | HFCM-0404R | 1/2 | 1/2 | 11 | 20 | 18 | 19 | 48 | 46 | 27 |
| HMCM-0406R | HFCM-0406R | 1/2 | 3/4 | 11 | 20 | 18 | 21 | 50 | 48 | 30 |
| HMCM-0604R | HFCM-0604R | 3/4 | 1/2 | 12 | 22 | 20 | 19 | 52 | 50 | 32 |
| HMCM-0606R | HFCM-0606R | 3/4 | 3/4 | 16 | 22 | 20 | 21 | 54 | 52 | 32 |
| HMCM-0608R | HFCM-0608R | 3/4 | 1 | 16 | 22 | 20 | 24 | 57 | 55 | 36 |
| HMCM-0806R | HFCM-0806R | 1 | 3/4 | 16 | 23 | 22 | 21 | 55 | 54 | 41 |
| HMCM-0808R | HFCM-0808R | 1 | 1 | 22 | 23 | 22 | 24 | 58 | 57 | 41 |

All dimensions are in millimeters. Dimensions are for reference only, subject to change.

Hydraulic Hose Fittings

MALE HOSE TO FEMALE CONNECTOR

HMCF

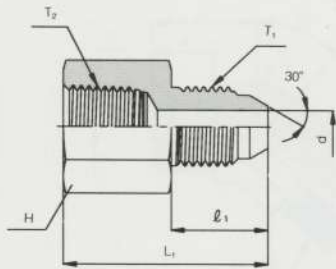

FEMALE HOSE TO FEMALE CONNECTOR

HFCF

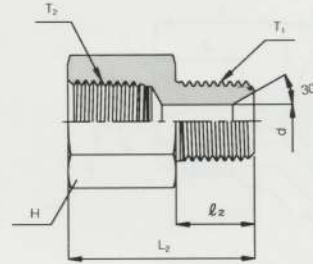

| PART No. | T ₁ G(PF) | T ₂ R(PT) | d | l ₁ | l ₂ | L ₁ | L ₂ | H |
|------------|-------------------------|-------------------------|-----|----------------|----------------|----------------|----------------|----|
| HMCF-0202R | 1/4 | 1/4 | 5.5 | 16 | 13 | 32 | 31 | 19 |
| HMCF-0303R | 3/8 | 3/8 | 8 | 18 | 15 | 37 | 34 | 22 |
| HMCF-0404R | 1/2 | 1/2 | 11 | 20 | 18 | 42 | 42 | 27 |
| HMCF-0606R | 3/4 | 3/4 | 16 | 22 | 20 | 47 | 45 | 36 |
| HMCF-0808R | 1 | 1 | 22 | 23 | 22 | 51 | 51 | 41 |

MALE HOSE TO MALE 90° ELBOW

HMAM

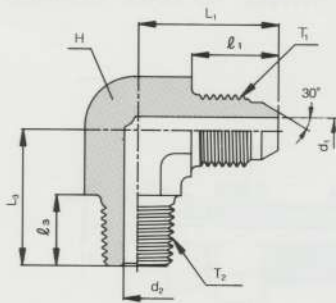

FEMALE HOSE TO MALE 90° ELBOW

HFAM

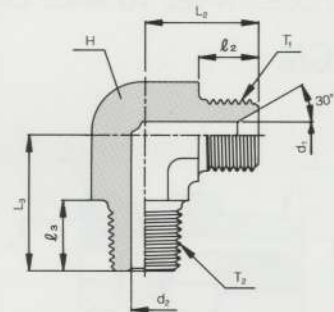

| PART No. | T ₁ G(PF) | T ₂ R(PT) | d ₁ | d ₂ | l ₁ | l ₂ | l ₃ | L ₁ | L ₂ | L ₃ | H |
|------------|-------------------------|-------------------------|----------------|----------------|----------------|----------------|----------------|----------------|----------------|----------------|----|
| HMAM-0202R | 1/4 | 1/4 | 5.5 | 7 | 16 | 13 | 14 | 26 | 23 | 24 | 17 |
| HMAM-0203R | 1/4 | 3/8 | 5.5 | 9 | 16 | 13 | 15 | 27 | 24 | 26 | 19 |
| HMAM-0302R | 3/8 | 1/4 | 8 | 7 | 18 | 15 | 14 | 29 | 26 | 25 | 19 |
| HMAM-0303R | 3/8 | 3/8 | 8 | 9 | 18 | 15 | 15 | 29 | 26 | 26 | 19 |
| HMAM-0304R | 3/8 | 1/2 | 8 | 12 | 18 | 15 | 19 | 32 | 29 | 33 | 24 |
| HMAM-0403R | 1/2 | 3/8 | 11 | 9 | 20 | 18 | 15 | 34 | 32 | 29 | 24 |
| HMAM-0404R | 1/2 | 1/2 | 11 | 12 | 20 | 18 | 19 | 34 | 32 | 33 | 24 |
| HMAM-0406R | 1/2 | 3/4 | 11 | 16 | 20 | 18 | 21 | 38 | 36 | 39 | 27 |
| HMAM-0604R | 3/4 | 1/2 | 16 | 12 | 22 | 20 | 19 | 40 | 38 | 37 | 27 |
| HMAM-0606R | 3/4 | 3/4 | 16 | 16 | 22 | 20 | 21 | 40 | 38 | 39 | 27 |
| HMAM-0608R | 3/4 | 1 | 16 | 22 | 22 | 20 | 24 | 42 | 41 | 50 | 36 |
| HMAM-0806R | 1 | 3/4 | 22 | 16 | 23 | 22 | 21 | 42 | 41 | 48 | 36 |
| HMAM-0808R | 1 | 1 | 22 | 22 | 23 | 22 | 24 | 42 | 41 | 50 | 36 |

All dimensions are in millimeters. Dimensions are for reference only, subject to change.

Hydraulic Hose Fittings

MALE HOSE TO MALE 45° ELBOW

HMBM

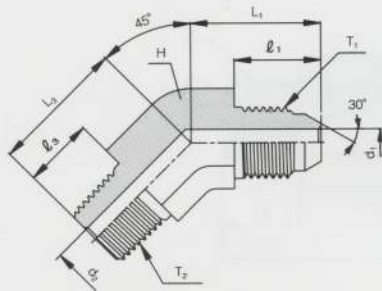

FEMALE HOSE TO MALE 45° ELBOW

HFBM

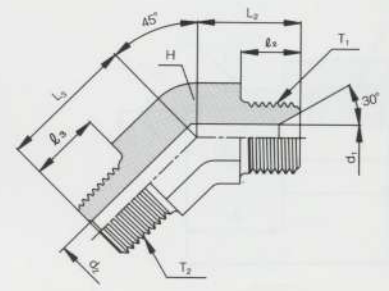

| PART No. | No. | T ₁ G(PF) | T ₂ R(PT) | d ₁ | d ₂ | l ₁ | l ₂ | l ₃ | L ₁ | L ₂ | L ₃ | H |
|------------|------------|-------------------------|-------------------------|----------------|----------------|----------------|----------------|----------------|----------------|----------------|----------------|----|
| HMBM-0202R | HFBM-0202R | 1/4 | 1/4 | 5.5 | 7 | 16 | 13 | 14 | 24 | 21 | 22 | 14 |
| HMBM-0203R | HFBM-0203R | 1/4 | 3/8 | 5.5 | 9 | 16 | 13 | 15 | 24 | 21 | 23 | 19 |
| HMBM-0302R | HFBM-0302R | 3/8 | 1/4 | 8 | 7 | 18 | 15 | 14 | 26 | 23 | 22 | 19 |
| HMBM-0303R | HFBM-0303R | 3/8 | 3/8 | 8 | 9 | 18 | 15 | 15 | 26 | 23 | 23 | 19 |
| HMBM-0304R | HFBM-0304R | 3/8 | 1/2 | 8 | 12 | 18 | 15 | 19 | 28 | 25 | 29 | 22 |
| HMBM-0403R | HFBM-0403R | 1/2 | 3/8 | 11 | 9 | 20 | 18 | 15 | 30 | 28 | 25 | 22 |
| HMBM-0404R | HFBM-0404R | 1/2 | 1/2 | 11 | 12 | 20 | 18 | 19 | 30 | 28 | 29 | 22 |
| HMBM-0606R | HFBM-0606R | 3/4 | 3/4 | 16 | 16 | 22 | 20 | 21 | 35 | 33 | 34 | 27 |
| HMBM-0808R | HFBM-0808R | 1 | 1 | 22 | 22 | 23 | 22 | 24 | 39 | 39 | 37 | 36 |

MALE HOSE SWIVEL TO MALE CONNECTOR

HSMCM

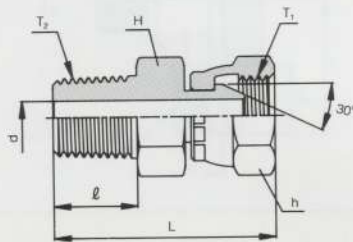

FEMALE HOSE SWIVEL TO MALE CONNECTOR

HSFCM

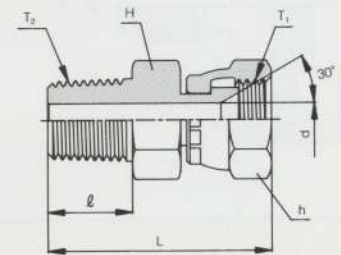

| PART No. | No. | T ₁ G(PF) | T ₂ R(PT) | d | l | Approx L | h | H |
|-------------|-------------|-------------------------|-------------------------|-----|----|-------------|----|----|
| HSMCM-0202R | HSFCM-0202R | 1/4 | 1/4 | 5.5 | 14 | 37 | 19 | 19 |
| HSMCM-0203R | HSFCM-0203R | 1/4 | 3/8 | 5.5 | 15 | 38 | 19 | 19 |
| HSMCM-0302R | HSFCM-0302R | 3/8 | 1/4 | 7 | 14 | 43 | 22 | 22 |
| HSMCM-0303R | HSFCM-0303R | 3/8 | 3/8 | 8 | 15 | 44 | 22 | 22 |
| HSMCM-0304R | HSFCM-0304R | 3/8 | 1/2 | 8 | 19 | 48 | 22 | 24 |
| HSMCM-0403R | HSFCM-0403R | 1/2 | 3/8 | 9 | 15 | 47 | 27 | 24 |
| HSMCM-0404R | HSFCM-0404R | 1/2 | 1/2 | 11 | 19 | 51 | 27 | 24 |
| HSMCM-0606R | HSFCM-0606R | 3/4 | 3/4 | 16 | 21 | 59 | 36 | 32 |
| HSMCM-0808R | HSFCM-0808R | 1 | 1 | 22 | 24 | 64 | 41 | 41 |

All dimensions are in millimeters. Dimensions are for reference only, subject to change.

Hydraulic Hose Fittings

MALE HOSE SWIVEL TO
FEMALE CONNECTOR
HSMCF

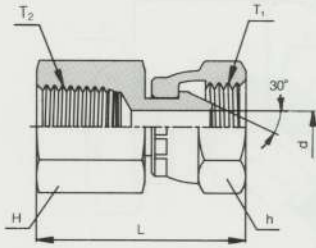

FEMALE HOSE SWIVEL TO
FEMALE CONNECTOR
HSFCF

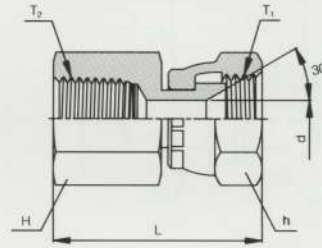

| PART No. | | T ₁ G(PF) | T ₂ R(PT) | d | Approx L | h | H |
|-------------|-------------|-------------------------|-------------------------|-----|-------------|----|----|
| HSMCF-0202R | HSFCF-0202R | 1/4 | 1/4 | 5.5 | 33 | 19 | 19 |
| HSMCF-0203R | HSFCF-0203R | 1/4 | 3/8 | 5.5 | 35 | 19 | 22 |
| HSMCF-0302R | HSFCF-0302R | 3/8 | 1/4 | 8 | 38 | 22 | 22 |
| HSMCF-0303R | HSFCF-0303R | 3/8 | 3/8 | 8 | 39 | 22 | 22 |
| HSMCF-0304R | HSFCF-0304R | 3/8 | 1/2 | 8 | 42 | 22 | 27 |
| HSMCF-0403R | HSFCF-0403R | 1/2 | 3/8 | 11 | 42 | 27 | 22 |
| HSMCF-0404R | HSFCF-0404R | 1/2 | 1/2 | 11 | 48 | 27 | 27 |
| HSMCF-0606R | HSFCF-0606R | 3/4 | 3/4 | 16 | 51 | 36 | 36 |
| HSMCF-0808R | HSFCF-0808R | 1 | 1 | 22 | 55 | 41 | 41 |
| HSMCF-0806R | HSFCF-0806R | 3/4 | 1 | 16 | 58 | 36 | 41 |

MALE HOSE SWIVEL TO MALE 90° ELBOW

HSMAM

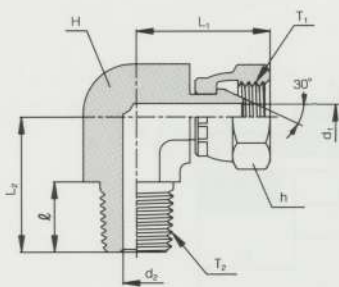

FEMALE HOSE SWIVEL TO MALE 90° ELBOW

HSFAM

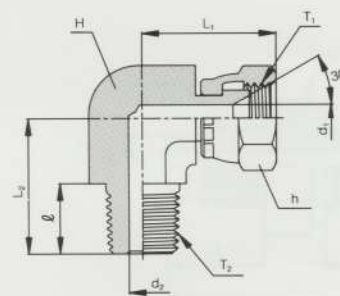

| PART No. | | T ₁ G(PF) | T ₂ R(PT) | d ₁ | d ₂ | l | Approx L ₁ | L ₂ | l | H |
|-------------|-------------|-------------------------|-------------------------|----------------|----------------|----|--------------------------|----------------|----|----|
| HSMAM-0202R | HSFAM-0202R | 1/4 | 1/4 | 5.5 | 7 | 14 | 26 | 24 | 19 | 17 |
| HSMAM-0203R | HSFAM-0203R | 1/4 | 3/8 | 5.5 | 9 | 15 | 27 | 26 | 19 | 19 |
| HSMAM-0302R | HSFAM-0302R | 3/8 | 1/4 | 8 | 7 | 14 | 30 | 25 | 22 | 19 |
| HSMAM-0303R | HSFAM-0303R | 3/8 | 3/8 | 8 | 9 | 15 | 30 | 26 | 22 | 19 |
| HSMAM-0304R | HSFAM-0304R | 3/8 | 1/2 | 8 | 12 | 19 | 33 | 33 | 22 | 24 |
| HSMAM-0403R | HSFAM-0403R | 1/2 | 3/8 | 11 | 9 | 15 | 37 | 29 | 27 | 24 |
| HSMAM-0404R | HSFAM-0404R | 1/2 | 1/2 | 11 | 12 | 19 | 37 | 33 | 27 | 24 |
| HSMAM-0606R | HSFAM-0606R | 3/4 | 3/4 | 16 | 16 | 21 | 45 | 39 | 36 | 30 |
| HSMAM-0808R | HSFAM-0808R | 1 | 1 | 22 | 22 | 24 | 51 | 45 | 41 | 36 |

All dimensions are in millimeters. Dimensions are for reference only, subject to chang.

Hydraulic Hose Fittings

MALE HOSE SWIVEL TO
MALE 45° ELBOW
HSMBM

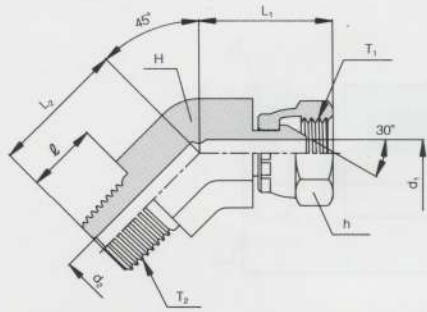

FEMALE HOSE SWIVEL TO
MALE 45° ELBOW
HSFBM

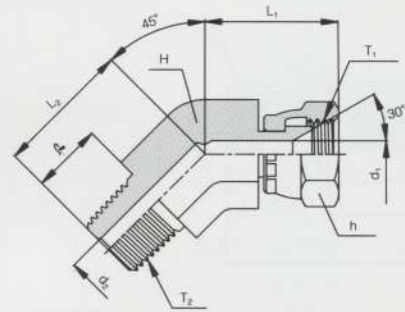

| PART No. | No. | T ₁ G(PF) | T ₂ R(PT) | d ₁ | d ₂ | ℓ | Approx L ₁ | L ₂ | h | H |
|-------------|-------------|-------------------------|-------------------------|----------------|----------------|----|--------------------------|----------------|----|----|
| HSMBM-0202R | HSFBM-0202R | 1/4 | 1/4 | 5.5 | 7 | 14 | 23 | 21 | 19 | 17 |
| HSMBM-0203R | HSFBM-0203R | 1/4 | 3/8 | 5.5 | 9 | 15 | 24 | 23 | 19 | 19 |
| HSMBM-0302R | HSFBM-0302R | 3/8 | 1/4 | 8 | 7 | 14 | 27 | 22 | 22 | 19 |
| HSMBM-0303R | HSFBM-0303R | 3/8 | 3/8 | 8 | 9 | 15 | 27 | 23 | 22 | 19 |
| HSMBM-0304R | HSFBM-0304R | 3/8 | 1/2 | 8 | 12 | 19 | 29 | 29 | 22 | 24 |
| HSMBM-0403R | HSFBM-0403R | 1/2 | 3/8 | 11 | 9 | 15 | 33 | 25 | 27 | 24 |
| HSMBM-0404R | HSFBM-0404R | 1/2 | 1/2 | 11 | 12 | 19 | 33 | 29 | 27 | 24 |
| HSMBM-0606R | HSFBM-0606R | 3/4 | 3/4 | 16 | 16 | 21 | 40 | 34 | 36 | 30 |
| HSMBM-0808R | HSFBM-0808R | 1 | 1 | 22 | 22 | 24 | 44 | 41 | 41 | 36 |

MALE HOSE TO STRAIGHT PIPE THREAD
O - RING BOSS CONNECTOR
HOMCM - G

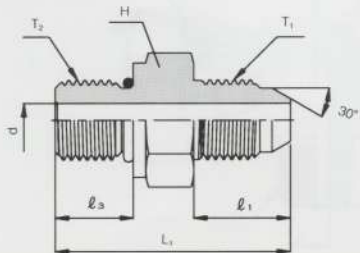

FEMALE HOSE TO STRAIGHT PIPE THREAD
O - RING BOSS CONNECTOR
HOFM - G



| PART No. | No. | T ₁ G(PF) | T ₂ G(PF) | d | ℓ ₁ | ℓ ₂ | ℓ ₃ | L ₁ | L ₂ | H |
|-------------|------------|-------------------------|-------------------------|-----|----------------|----------------|----------------|----------------|----------------|----|
| HOMCM-0202G | HOFM-0202G | 1/4 | 1/4 | 5.5 | 16 | 13 | 12 | 35 | 32 | 19 |
| HOMCM-0203G | HOFM-0203G | 1/4 | 3/8 | 5.5 | 16 | 13 | 12 | 35 | 32 | 22 |
| HOMCM-0302G | HOFM-0302G | 3/8 | 1/4 | 5.5 | 18 | 15 | 12 | 37 | 34 | 19 |
| HOMCM-0303G | HOFM-0303G | 3/8 | 3/8 | 8 | 18 | 15 | 12 | 37 | 34 | 22 |
| HOMCM-0304G | HOFM-0304G | 3/8 | 1/2 | 8 | 18 | 15 | 14 | 41 | 38 | 27 |
| HOMCM-0403G | HOFM-0403G | 1/2 | 3/8 | 8 | 20 | 18 | 12 | 41 | 39 | 22 |
| HOMCM-0404G | HOFM-0404G | 1/2 | 1/2 | 11 | 20 | 18 | 14 | 43 | 41 | 27 |
| HOMCM-0606G | HOFM-0606G | 3/4 | 3/4 | 16 | 22 | 20 | 16 | 48 | 46 | 36 |
| HOMCM-0808G | HOFM-0808G | 1 | 1 | 22 | 23 | 22 | 18 | 55 | 53 | 41 |

All dimensions are in millimeters. Dimensions are for reference only, subject to change.

Hydraulic Hose Fittings

MALE HOSE TO SAE / MS STRAIGHT THREAD
O - RING BOSS CONNECTOR
HOMCM - U

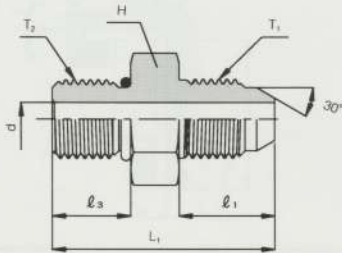

FEMALE HOSE TO SAE / MS STRAIGHT THREAD
O - RING BOSS CONNECTOR
HOFCM - U

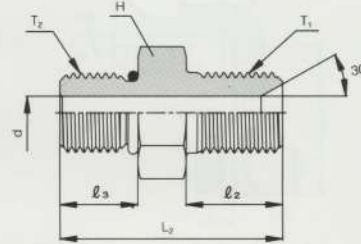

| PART No. | T ₁ G(PF) | T ₂ R(UNF) | d | l ₁ | l ₂ | l ₃ | L ₁ | L ₂ | H | |
|-------------|-------------------------|--------------------------|-------------|----------------|----------------|----------------|----------------|----------------|----|------|
| HOMCM-0204U | HOFCM-0204U | 1/4 | 7/16 - 20 | 4 | 16 | 13 | 10 | 33 | 30 | 14.2 |
| HOMCM-0205U | HOFCM-0205U | 1/4 | 1/2 - 20 | 5.5 | 16 | 13 | 11 | 34 | 31 | 15.8 |
| HOMCM-0306U | HOFCM-0306U | 3/8 | 9/16 - 18 | 8 | 18 | 15 | 14 | 39 | 36 | 17.4 |
| HOMCM-0308U | HOFCM-0308U | 3/8 | 3/4 - 16 | 8 | 18 | 15 | 14 | 39 | 36 | 22.2 |
| HOMCM-0310U | HOFCM-0310U | 3/8 | 7/8 - 14 | 8 | 18 | 15 | 14 | 40 | 37 | 25.4 |
| HOMCM-0408U | HOFCM-0408U | 1/2 | 3/4 - 16 | 10 | 20 | 18 | 14 | 42 | 40 | 22.2 |
| HOMCM-0410U | HOFCM-0410U | 1/2 | 7/8 - 14 | 11 | 20 | 18 | 14 | 42 | 40 | 25.4 |
| HOMCM-0412U | HOFCM-0412U | 1/2 | 1-1/16 - 12 | 11 | 20 | 18 | 17 | 46 | 44 | 32 |
| HOMCM-0612U | HOFCM-0612U | 3/4 | 1-1/16 - 12 | 16 | 22 | 20 | 17 | 46 | 44 | 32 |
| HOMCM-0616U | HOFCM-0616U | 3/4 | 1-5/16 - 12 | 16 | 22 | 20 | 18 | 50 | 48 | 38 |
| HOMCM-0816U | HOFCM-0816U | 1 | 1-5/16 - 12 | 22 | 23 | 22 | 18 | 53 | 52 | 38 |

INSTALLATION INSTRUCTIONS

STRAIGHT THREAD O - RING BOSS FITTINGS

- O - Ring has to be lubricated with slight coat of system fluid or its compatible oil.
- Insert it in the groove up to the face of the metal back-up washer that is pre - installed at the extreme end of the same groove.
- Screw the fitting into boss until the face of boss reaches up to the metal back - up washer.

- Unscrew the fitting to the direction of incoming hose assembly within maximum one full turn.
- Tighten the locknut by holding fitting in desired position with wrench until the washer is fully faced with the face of the boss.

PRECAUTION TO PREVENT LEAK.

Make sure of O-Ring being not pinched and back-up washer seating flat.

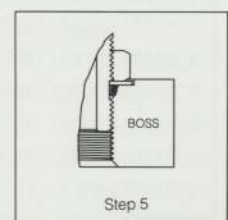
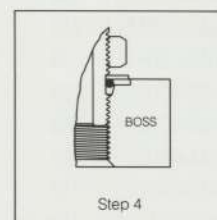
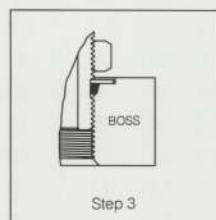
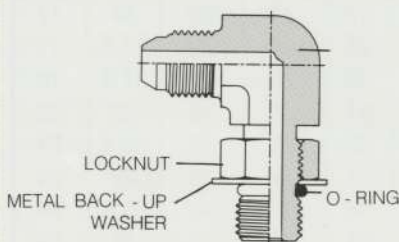

All dimensions are in millimeters. Dimensions are for reference only, subject to chang.

Hydraulic Hose Fittings

MALE HOSE TO STRAIGHT PIPE THREAD
O - RING BOSS 90° ELBOW
HOMAM - G

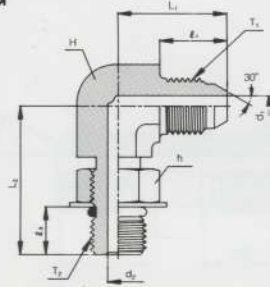

FEMALE HOSE TO STRAIGHT PIPE THREAD
O - RING BOSS 90° ELBOW
HOFAM - G

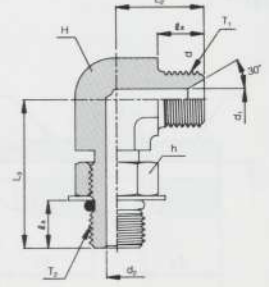

| PART No. | T ₁ G(PF) | T ₂ G(PF) | d ₁ | d ₂ | ℓ ₁ | ℓ ₂ | ℓ ₃ | L ₁ | L ₂ | L ₃ | h | H | |
|-------------|-------------------------|-------------------------|----------------|----------------|----------------|----------------|----------------|----------------|----------------|----------------|----|----|----|
| HOMAM-0202G | HOFAM-0202G | 1/4 | 1/4 | 5.5 | 5.5 | 16 | 13 | 11 | 27 | 24 | 36 | 19 | 17 |
| HOMAM-0203G | HOFAM-0203G | 1/4 | 3/8 | 5.5 | 8 | 16 | 13 | 13 | 27 | 24 | 37 | 22 | 19 |
| HOMAM-0302G | HOFAM-0302G | 3/8 | 1/4 | 8 | 5.5 | 18 | 15 | 11 | 29 | 26 | 36 | 19 | 19 |
| HOMAM-0303G | HOFAM-0303G | 3/8 | 3/8 | 8 | 8 | 18 | 15 | 13 | 29 | 26 | 37 | 22 | 19 |
| HOMAM-0304G | HOFAM-0304G | 3/8 | 1/2 | 8 | 11 | 18 | 15 | 15 | 32 | 26 | 46 | 27 | 24 |
| HOMAM-0403G | HOFAM-0403G | 1/2 | 3/8 | 11 | 8 | 20 | 18 | 11 | 34 | 32 | 40 | 22 | 24 |
| HOMAM-0404G | HOFAM-0404G | 1/2 | 1/2 | 11 | 11 | 20 | 18 | 15 | 34 | 32 | 46 | 27 | 24 |
| HOMAM-0406G | HOFAM-0406G | 1/2 | 3/4 | 11 | 16 | 20 | 18 | 16 | 38 | 36 | 52 | 36 | 32 |
| HOMAM-0604G | HOFAM-0604G | 3/4 | 1/2 | 16 | 11 | 22 | 20 | 15 | 38 | 38 | 50 | 27 | 32 |
| HOMAM-0606G | HOFAM-0606G | 3/4 | 3/4 | 16 | 16 | 22 | 20 | 16 | 38 | 38 | 52 | 36 | 32 |
| HOMAM-0808G | HOFAM-0808G | 1 | 1 | 22 | 22 | 23 | 22 | 18 | 42 | 42 | 62 | 41 | 36 |

MALE HOSE TO SAE / MS STRAIGHT THREAD
O - RING BOSS 90° ELBOW
HOMAM - U

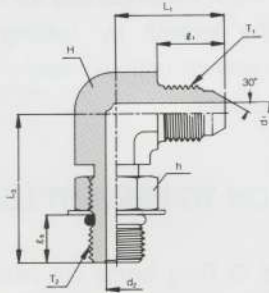

FEMALE HOSE TO SAE / MS STRAIGHT THREAD
O - RING BOSS 90° ELBOW
HOFAM - U

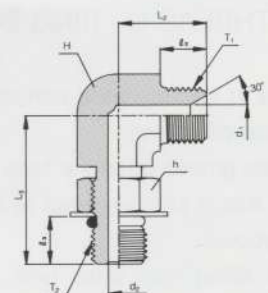

| PART No. | T ₁ G(PF) | T ₂ (UNF) | d ₁ | d ₂ | ℓ ₁ | ℓ ₂ | ℓ ₃ | L ₁ | L ₂ | L ₃ | h | H | |
|-------------|-------------------------|-------------------------|----------------|----------------|----------------|----------------|----------------|----------------|----------------|----------------|----|------|----|
| HOMAM-0204U | HOFAM-0204U | 1/4 | 7/16 - 20 | 5.5 | 4 | 16 | 13 | 10 | 27 | 24 | 29 | 14 | 17 |
| HOMAM-0205U | HOFAM-0205U | 1/4 | 1/2 - 20 | 5.5 | 5.5 | 16 | 13 | 11 | 27 | 24 | 29 | 15.8 | 17 |
| HOMAM-0306U | HOFAM-0306U | 3/8 | 9/16 - 18 | 8 | 8 | 18 | 15 | 14 | 29 | 26 | 31 | 17.4 | 19 |
| HOMAM-0308U | HOFAM-0308U | 3/8 | 3/4 - 16 | 8 | 10 | 18 | 15 | 14 | 31 | 28 | 36 | 22 | 22 |
| HOMAM-0310U | HOFAM-0310U | 3/8 | 7/8 - 14 | 8 | 12 | 18 | 15 | 14 | 32 | 29 | 40 | 25.4 | 24 |
| HOMAM-0408U | HOFAM-0408U | 1/2 | 3/4 - 16 | 11 | 10 | 20 | 18 | 14 | 33 | 31 | 36 | 22 | 24 |
| HOMAM-0410U | HOFAM-0410U | 1/2 | 7/8 - 14 | 11 | 12 | 20 | 18 | 14 | 34 | 32 | 40 | 25.4 | 24 |
| HOMAM-0412U | HOFAM-0412U | 1/2 | 1-1/16 - 12 | 11 | 16 | 20 | 18 | 17 | 38 | 36 | 48 | 32 | 32 |
| HOMAM-0612U | HOFAM-0612U | 3/4 | 1-1/16 - 12 | 16 | 16 | 22 | 20 | 17 | 40 | 38 | 48 | 32 | 32 |
| HOMAM-0616U | HOFAM-0616U | 3/4 | 1-5/16 - 12 | 16 | 22 | 22 | 20 | 18 | 42 | 38 | 51 | 38 | 36 |
| HOMAM-0816U | HOFAM-0816U | 1 | 1-5/16 - 12 | 22 | 22 | 23 | 22 | 18 | 42 | 42 | 51 | 38 | 36 |

All dimensions are in millimeters. Dimensions are for reference only, subject to change.

Hydraulic Hose Fittings

MALE HOSE TO STRAIGHT PIPE THREAD
O - RING BOSS 45° ELBOW
HOMBM - G

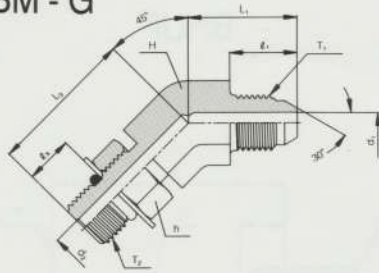

FEMALE HOSE TO STRAIGHT PIPE THREAD
O - RING BOSS 45° ELBOW
HOFBM - G

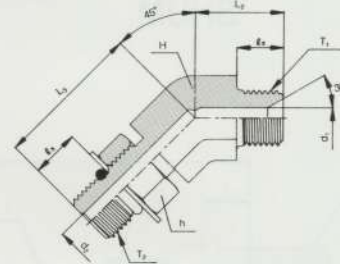

| PART No. | T ₁ G(PF) | T ₂ G(PF) | d ₁ | d ₂ | ℓ ₁ | ℓ ₂ | ℓ ₃ | L ₁ | L ₂ | L ₃ | h | H | |
|-------------|-------------------------|-------------------------|----------------|----------------|----------------|----------------|----------------|----------------|----------------|----------------|----|----|----|
| HOMBM-0202G | HOFBM-0202G | 1/4 | 1/4 | 5.5 | 5.5 | 16 | 13 | 11 | 24 | 21 | 33 | 19 | 19 |
| HOMBM-0203G | HOFBM-0203G | 1/4 | 3/8 | 5.5 | 8 | 16 | 13 | 13 | 24 | 21 | 34 | 22 | 19 |
| HOMBM-0302G | HOFBM-0302G | 3/8 | 1/4 | 8 | 5.5 | 18 | 15 | 11 | 26 | 23 | 33 | 19 | 19 |
| HOMBM-0303G | HOFBM-0303G | 3/8 | 3/8 | 8 | 8 | 18 | 15 | 13 | 26 | 23 | 34 | 22 | 19 |
| HOMBM-0304G | HOFBM-0304G | 3/8 | 1/2 | 8 | 11 | 18 | 15 | 15 | 28 | 25 | 42 | 27 | 24 |
| HOMBM-0403G | HOFBM-0403G | 1/2 | 3/8 | 11 | 8 | 20 | 18 | 11 | 30 | 28 | 36 | 22 | 24 |
| HOMBM-0404G | HOFBM-0404G | 1/2 | 1/2 | 11 | 11 | 20 | 18 | 15 | 30 | 28 | 42 | 27 | 24 |
| HOMBM-0406G | HOFBM-0406G | 1/2 | 3/4 | 11 | 16 | 20 | 18 | 16 | 33 | 31 | 47 | 36 | 27 |
| HOMBM-0604G | HOFBM-0604G | 3/4 | 1/2 | 16 | 11 | 22 | 20 | 15 | 35 | 33 | 45 | 27 | 27 |
| HOMBM-0606G | HOFBM-0606G | 3/4 | 3/4 | 16 | 16 | 22 | 20 | 16 | 35 | 33 | 47 | 36 | 27 |
| HOMBM-0808G | HOFBM-0808G | 1 | 1 | 22 | 22 | 23 | 22 | 18 | 40 | 39 | 58 | 41 | |

MALE HOSE TO SAE / MS STRAIGHT THREAD
O - RING BOSS 45° ELBOW
HOMBM - U

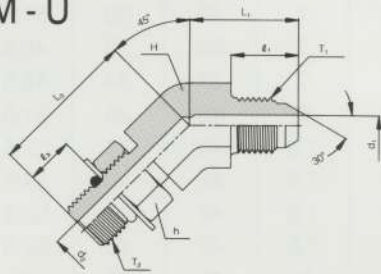

FEMALE HOSE TO SAE / MS STRAIGHT THREAD
O - RING BOSS 45° ELBOW
HOFBM - U

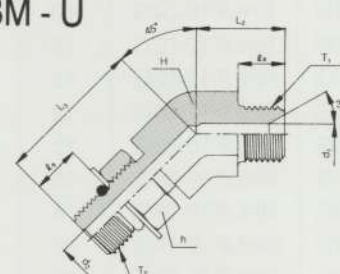

| PART No. | T ₁ G(PF) | T ₂ (UNF) | d ₁ | d ₂ | ℓ ₁ | ℓ ₂ | ℓ ₃ | L ₁ | L ₂ | L ₃ | h | H | |
|-------------|-------------------------|-------------------------|----------------|----------------|----------------|----------------|----------------|----------------|----------------|----------------|----|------|----|
| HOMBM-0204U | HOFBM-0204U | 1/4 | 7/16 - 20 | 5.5 | 4 | 16 | 13 | 10 | 24 | 21 | 26 | 14 | 17 |
| HOMBM-0205U | HOFBM-0205U | 1/4 | 1/2 - 20 | 5.5 | 5.5 | 16 | 13 | 11 | 24 | 21 | 26 | 15.8 | 17 |
| HOMBM-0306U | HOFBM-0306U | 3/8 | 9/16 - 18 | 8 | 8 | 18 | 15 | 14 | 26 | 23 | 28 | 17.4 | 19 |
| HOMBM-0308U | HOFBM-0308U | 3/8 | 3/4 - 16 | 8 | 10 | 18 | 15 | 14 | 28 | 25 | 33 | 22 | 22 |
| HOMBM-0310U | HOFBM-0310U | 3/8 | 7/8 - 14 | 8 | 12 | 18 | 15 | 14 | 28 | 25 | 36 | 25.4 | 24 |
| HOMBM-0408U | HOFBM-0408U | 1/2 | 3/4 - 16 | 11 | 10 | 20 | 18 | 14 | 30 | 28 | 33 | 22 | 22 |
| HOMBM-0410U | HOFBM-0410U | 1/2 | 7/8 - 14 | 11 | 12 | 20 | 18 | 14 | 30 | 28 | 36 | 25.4 | 24 |
| HOMBM-0412U | HOFBM-0412U | 1/2 | 1-1/16 - 12 | 11 | 16 | 20 | 18 | 17 | 33 | 31 | 43 | 32 | 30 |
| HOMBM-0612U | HOFBM-0612U | 3/4 | 1-1/16 - 12 | 16 | 16 | 22 | 20 | 17 | 35 | 33 | 43 | 32 | 30 |
| HOMBM-0616U | HOFBM-0616U | 3/4 | 1-5/16 - 12 | 16 | 22 | 22 | 20 | 18 | 39 | 37 | 47 | 38 | 36 |
| HOMBM-0816U | HOFBM-0816U | 1 | 1-5/16 - 12 | 22 | 22 | 23 | 22 | 18 | 40 | 39 | 47 | 38 | 36 |

All dimensions are in millimeters. Dimensions are for reference only, subject to change.

Hydraulic Hose Fittings

BITE TO MALE HOSE UNION

BHUM

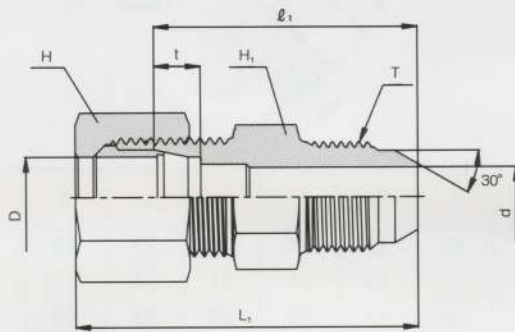

BITE TO FEMALE HOSE UNION

BHUF

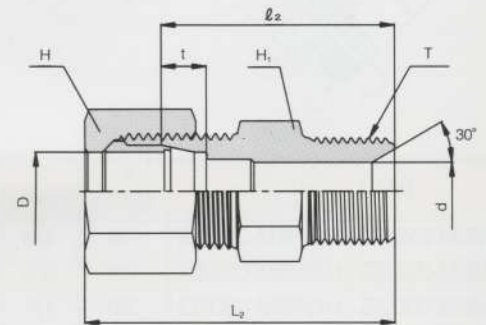

| PART No. | Tube O · D | T G(PF) | d | H ₁ | H | t | ℓ ₁ | ℓ ₂ | Approx L ₁ | Approx L ₂ | |
|------------|------------|---------|-------|----------------|----|----|----------------|----------------|-----------------------|-----------------------|------|
| BHUM08-02G | BHUF08-02G | 8 | 1/4 | 6 | 17 | 17 | 7 | 35 | 33 | 45.5 | 43.5 |
| BHUM08-03G | BHUF08-03G | 8 | 3/8 | 6 | 19 | 17 | 7 | 37 | 34 | 47.5 | 44.5 |
| BHUM10-02G | BHUF10-02G | 10 | 1/4 | 6 | 17 | 19 | 7 | 35 | 33 | 46.5 | 44.5 |
| BHUM10-03G | BHUF10-03G | 10 | 3/8 | 8 | 19 | 19 | 7 | 37 | 34 | 48.5 | 45.5 |
| BHUM10-04G | BHUF10-04G | 10 | 1/2 | 8 | 22 | 19 | 7 | 40 | 38 | 51.5 | 49.5 |
| BHUM12-02G | BHUF12-02G | 12 | 1/4 | 6 | 19 | 22 | 7 | 35 | 33 | 46.5 | 44.5 |
| BHUM12-03G | BHUF12-03G | 12 | 3/8 | 9 | 19 | 22 | 7 | 37 | 34 | 48.5 | 45.5 |
| BHUM12-04G | BHUF12-04G | 12 | 1/2 | 10 | 22 | 22 | 7 | 40 | 38 | 51.5 | 49.5 |
| BHUM15-03G | BHUF15-03G | 15 | 3/8 | 9 | 24 | 27 | 7.5 | 40 | 37 | 52.5 | 49.5 |
| BHUM15-04G | BHUF15-04G | 15 | 1/2 | 12 | 24 | 27 | 7.5 | 42 | 40 | 54.5 | 52.5 |
| BHUM16-03G | BHUF16-03G | 16 | 3/8 | 9 | 27 | 30 | 7.5 | 40 | 37 | 52.5 | 49.5 |
| BHUM16-04G | BHUF16-04G | 16 | 1/2 | 12 | 27 | 30 | 7.5 | 42 | 40 | 54.5 | 52.5 |
| BHUM18-04G | BHUF18-04G | 18 | 1/2 | 12 | 27 | 32 | 8 | 42 | 40 | 54.5 | 52.5 |
| BHUM20-06G | BHUF20-06G | 20 | 3/4 | 16 | 30 | 36 | 8 | 46 | 43 | 58.5 | 55.5 |
| BHUM22-04G | BHUF22-04G | 22 | 1/2 | 12 | 32 | 36 | 9 | 44 | 42 | 56.5 | 54.5 |
| BHUM22-06G | BHUF22-06G | 22 | 3/4 | 16 | 32 | 36 | 9 | 46 | 43 | 58.5 | 55.5 |
| BHUM25-06G | BHUF25-06G | 25 | 3/4 | 16 | 36 | 41 | 10 | 47 | 44 | 60.5 | 57.5 |
| BHUM25-08G | BHUF25-08G | 25 | 1 | 20 | 36 | 41 | 10 | 49 | 46 | 62.5 | 59.5 |
| BHUM28-06G | BHUF28-06G | 28 | 3/4 | 16 | 41 | 46 | 10 | 49 | 46 | 63 | 60 |
| BHUM28-08G | BHUF28-08G | 28 | 1 | 22 | 41 | 46 | 10 | 51 | 48 | 65 | 62 |
| BHUM30-06G | BHUF30-06G | 30 | 3/4 | 16 | 41 | 46 | 10 | 49 | 46 | 63.5 | 60.5 |
| BHUM30-08G | BHUF30-08G | 30 | 1 | 22 | 41 | 46 | 10 | 51 | 48 | 65.5 | 62.5 |
| BHUM32-08G | BHUF32-08G | 32 | 1 | 22 | 46 | 50 | 11 | 52 | 49 | 66.5 | 63.5 |
| BHUM32-10G | BHUF32-10G | 32 | 1 1/4 | 28 | 46 | 50 | 11 | 56 | 55 | 70.5 | 69.5 |

All dimensions are in millimeters. Dimensions are for reference only, subject to change.

Hydraulic Hose Fittings

BITE TO MALE HOSE BULKHEAD UNION

BITE TO FEMALE HOSE BULKHEAD UNION

BHBM

BHBF

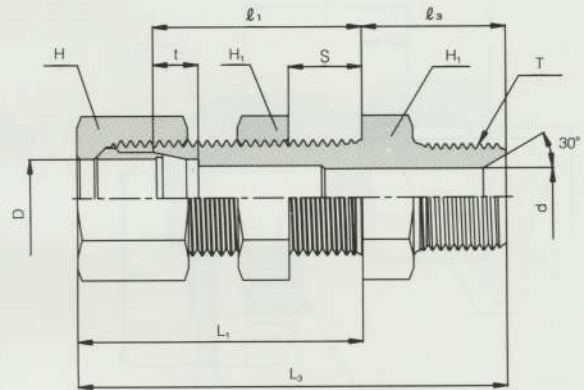
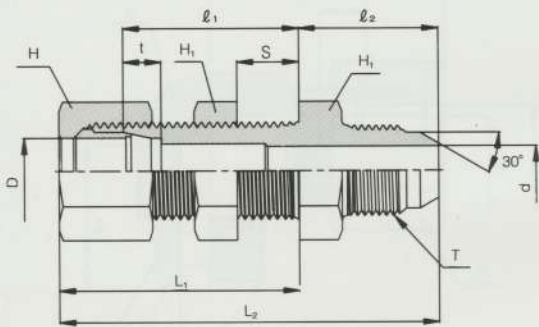

| PART No. | Tube O·D | T G(PF) | d | H ₁ | H | t | ℓ ₁ | ℓ ₂ | ℓ ₃ | Approx L ₁ | Approx L ₂ | Approx L ₃ | Panel Hole Drill size | Max Panel thickness S | |
|------------|------------|---------|-------|----------------|----|----|----------------|----------------|----------------|-----------------------|-----------------------|-----------------------|-----------------------|-----------------------|----|
| BHBM08-02G | BHBF08-02G | 8 | 1/4 | 6 | 19 | 17 | 7 | 32 | 23 | 21 | 42.5 | 65.5 | 63.5 | 14.5 | 13 |
| BHBM08-03G | BHBF08-03G | 8 | 3/8 | 6 | 19 | 17 | 7 | 32 | 25 | 22 | 42.5 | 67.5 | 64.5 | 14.5 | 13 |
| BHBM10-02G | BHBF10-02G | 10 | 1/4 | 6 | 22 | 19 | 7 | 32 | 24 | 22 | 43.5 | 67.5 | 65.5 | 16.5 | 13 |
| BHBM10-03G | BHBF10-03G | 10 | 3/8 | 8 | 22 | 19 | 7 | 32 | 26 | 23 | 43.5 | 69.5 | 66.5 | 16.5 | 13 |
| BHBM10-04G | BHBF10-04G | 10 | 1/2 | 8 | 22 | 19 | 7 | 32 | 28 | 26 | 43.5 | 71.5 | 69.5 | 16.5 | 13 |
| BHBM12-02G | BHBF12-02G | 12 | 1/4 | 6 | 24 | 22 | 7 | 32 | 24 | 22 | 43.5 | 67.5 | 65.5 | 18.5 | 13 |
| BHBM12-03G | BHBF12-03G | 12 | 3/8 | 9 | 24 | 22 | 7 | 32 | 26 | 23 | 43.5 | 69.5 | 66.5 | 18.5 | 13 |
| BHBM12-04G | BHBF12-04G | 12 | 1/2 | 10 | 24 | 22 | 7 | 32 | 28 | 26 | 43.5 | 71.5 | 69.5 | 18.5 | 13 |
| BHBM15-03G | BHBF15-03G | 15 | 3/8 | 9 | 27 | 27 | 7.5 | 37 | 26 | 23 | 49.5 | 75.5 | 72.5 | 22.5 | 15 |
| BHBM15-04G | BHBF15-04G | 15 | 1/2 | 12 | 27 | 27 | 7.5 | 37 | 28 | 26 | 49.5 | 77.5 | 75.5 | 22.5 | 15 |
| BHBM16-03G | BHBF16-03G | 16 | 3/8 | 9 | 30 | 30 | 7.5 | 37 | 28 | 25 | 49.5 | 77.5 | 74.5 | 24.5 | 15 |
| BHBM16-04G | BHBF16-04G | 16 | 1/2 | 12 | 30 | 30 | 7.5 | 37 | 30 | 28 | 49.5 | 79.5 | 77.5 | 24.5 | 15 |
| BHBM18-04G | BHBF18-04G | 18 | 1/2 | 12 | 32 | 32 | 8 | 39 | 30 | 28 | 51.5 | 81.5 | 79.5 | 26.5 | 15 |
| BHBM20-06G | BHBF20-06G | 20 | 3/4 | 16 | 32 | 36 | 8 | 39 | 32 | 29 | 51.5 | 83.5 | 80.5 | 28.5 | 15 |
| BHBM22-04G | BHBF22-04G | 22 | 1/2 | 12 | 36 | 36 | 9 | 39 | 31 | 29 | 51.5 | 82.5 | 80.5 | 30.5 | 15 |
| BHBM22-06G | BHBF22-06G | 22 | 3/4 | 16 | 36 | 36 | 9 | 39 | 33 | 30 | 51.5 | 84.5 | 81.5 | 30.5 | 15 |
| BHBM25-06G | BHBF25-06G | 25 | 3/4 | 16 | 41 | 41 | 10 | 39 | 33 | 30 | 52.5 | 87.5 | 82.5 | 35.5 | 15 |
| BHBM25-08G | BHBF25-08G | 25 | 1 | 20 | 41 | 41 | 10 | 39 | 35 | 32 | 52.5 | 89.5 | 84.5 | 35.5 | 15 |
| BHBM28-06G | BHBF28-06G | 28 | 3/4 | 16 | 46 | 46 | 10 | 41 | 34 | 31 | 55 | 89 | 86 | 38.5 | 15 |
| BHBM28-08G | BHBF28-08G | 28 | 1 | 22 | 46 | 46 | 10 | 41 | 36 | 33 | 55 | 91 | 88 | 38.5 | 15 |
| BHBM30-06G | BHBF30-06G | 30 | 3/4 | 16 | 46 | 46 | 10 | 41 | 34 | 31 | 55.5 | 89.5 | 86.5 | 40.5 | 15 |
| BHBM30-08G | BHBF30-08G | 30 | 1 | 22 | 46 | 46 | 10 | 41 | 36 | 33 | 55.5 | 91.5 | 88.5 | 40.5 | 15 |
| BHBM32-08G | BHBF32-08G | 32 | 1 | 22 | 50 | 50 | 11 | 43 | 38 | 35 | 57.5 | 95.5 | 92.5 | 42.5 | 15 |
| BHBM32-10G | BHBF32-10G | 32 | 1 1/4 | 28 | 50 | 50 | 11 | 43 | 42 | 41 | 57.5 | 99.5 | 98.5 | 42.5 | 15 |

All dimensions are in millimeters. Dimensions are for reference only, subject to change.

Hydraulic Hose Fittings

BITE TO MALE HOSE ELBOW

BHLM

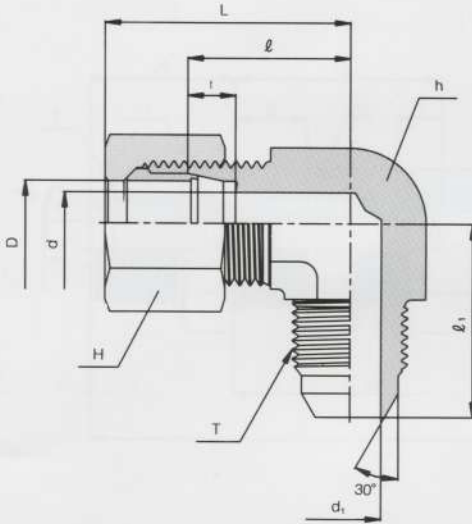

BITE TO FEMALE HOSE ELBOW

BHLF

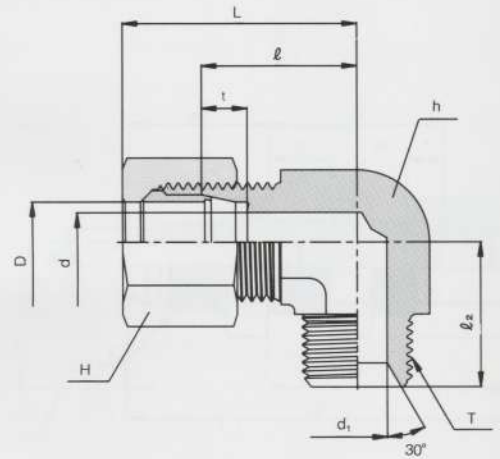

| PART No. | Tube O · D | T G(PF) | d | d ₁ | h | H | t | l | l ₁ | l ₂ | Approx L | |
|------------|------------|---------|-------|----------------|----|----|----|-----|----------------|----------------|----------|------|
| BHLM08-02G | BHLF08-02G | 8 | 1/4 | 6 | 6 | 17 | 17 | 7 | 23 | 25 | 25 | 33.5 |
| BHLM08-03G | BHLF08-03G | 8 | 3/8 | 6 | 9 | 19 | 17 | 7 | 24 | 28 | 27 | 34.5 |
| BHLM10-02G | BHLF10-02G | 10 | 1/4 | 8 | 6 | 19 | 19 | 7 | 24 | 28 | 26 | 35.5 |
| BHLM10-03G | BHLF10-03G | 10 | 3/8 | 8 | 9 | 19 | 19 | 7 | 24 | 28 | 27 | 35.5 |
| BHLM10-04G | BHLF10-04G | 10 | 1/2 | 8 | 12 | 24 | 19 | 7 | 29 | 34 | 33 | 40.5 |
| BHLM12-02G | BHLF12-02G | 12 | 1/4 | 10 | 6 | 19 | 22 | 7 | 24 | 28 | 26 | 35.5 |
| BHLM12-03G | BHLF12-03G | 12 | 3/8 | 10 | 9 | 19 | 22 | 7 | 24 | 28 | 27 | 35.5 |
| BHLM12-04G | BHLF12-04G | 12 | 1/2 | 10 | 12 | 24 | 22 | 7 | 29 | 34 | 33 | 40.5 |
| BHLM15-03G | BHLF15-03G | 15 | 3/8 | 12 | 9 | 24 | 27 | 7.5 | 29 | 33 | 30 | 41.5 |
| BHLM15-04G | BHLF15-04G | 15 | 1/2 | 12 | 12 | 24 | 27 | 7.5 | 29 | 34 | 33 | 41.5 |
| BHLM16-03G | BHLF16-03G | 16 | 3/8 | 13 | 9 | 27 | 30 | 7.5 | 32 | 36 | 33 | 44.5 |
| BHLM16-04G | BHLF16-04G | 16 | 1/2 | 13 | 12 | 27 | 30 | 7.5 | 32 | 38 | 36 | 44.5 |
| BHLM18-04G | BHLF18-04G | 18 | 1/2 | 14 | 12 | 27 | 32 | 8 | 32 | 38 | 36 | 44.5 |
| BHLM20-06G | BHLF20-06G | 20 | 3/4 | 17 | 16 | 30 | 36 | 8 | 33 | 41 | 38 | 45.5 |
| BHLM22-04G | BHLF22-04G | 22 | 1/2 | 18 | 12 | 32 | 36 | 9 | 34 | 40 | 38 | 46.5 |
| BHLM22-06G | BHLF22-06G | 22 | 3/4 | 18 | 16 | 32 | 36 | 9 | 34 | 42 | 39 | 46.5 |
| BHLM25-06G | BHLF25-06G | 25 | 3/4 | 20 | 16 | 36 | 41 | 10 | 36 | 44 | 41 | 49.5 |
| BHLM25-08G | BHLF25-08G | 25 | 1 | 20 | 20 | 36 | 41 | 10 | 36 | 46 | 43 | 49.5 |
| BHLM28-06G | BHLF28-06G | 28 | 3/4 | 22 | 16 | 41 | 46 | 10 | 41 | 47 | 44 | 55 |
| BHLM28-08G | BHLF28-08G | 28 | 1 | 22 | 22 | 41 | 46 | 10 | 41 | 49 | 46 | 55 |
| BHLM30-06G | BHLF30-06G | 30 | 3/4 | 25 | 16 | 41 | 46 | 10 | 41 | 47 | 44 | 55.5 |
| BHLM30-08G | BHLF30-08G | 30 | 1 | 25 | 22 | 41 | 46 | 10 | 41 | 49 | 46 | 55.5 |
| BHLM32-08G | BHLF32-08G | 32 | 1 | 26 | 22 | 46 | 50 | 11 | 46 | 54 | 51 | 60.5 |
| BHLM32-10G | BHLF32-10G | 32 | 1 1/4 | 26 | 28 | 46 | 50 | 11 | 46 | 56 | 57 | 60.5 |

All dimensions are in millimeters. Dimensions are for reference only, subject to change.

Hydraulic Hose Fittings

BITE TO MALE HOSE BULKHEAD ELBOW

BHBLM

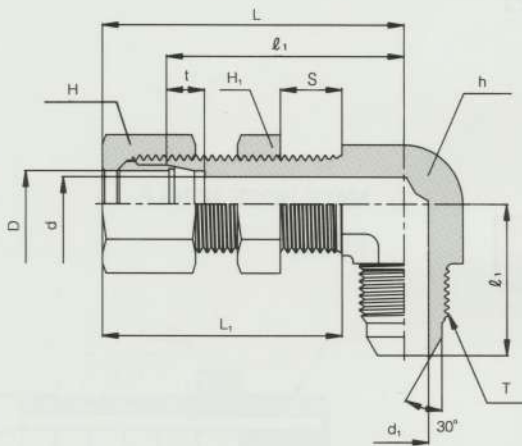

BITE TO FEMALE HOSE BULKHEAD ELBOW

BHBLF

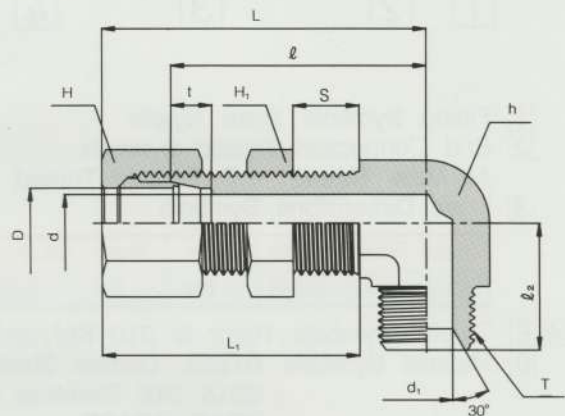

| PART No. | Tube O.D | T G(PF) | d | d ₁ | h | H ₁ | H | t | ℓ | ℓ ₁ | ℓ ₂ | Approx L ₁ | Approx L | Panel Hole Drill size | Max Panel thickness S | |
|-------------|-------------|---------|-----|----------------|----|----------------|----|----|-----|----------------|----------------|-----------------------|----------|-----------------------|-----------------------|----|
| BHBLM08-02G | BHBLF08-02G | 8 | 1/4 | 6 | 6 | 19 | 19 | 17 | 7 | 46 | 28 | 26 | 42.5 | 56.5 | 14.5 | 13 |
| BHBLM08-03G | BHBLF08-03G | 8 | 3/8 | 6 | 9 | 19 | 19 | 17 | 7 | 46 | 30 | 27 | 42.5 | 56.5 | 14.5 | 13 |
| BHBLM10-02G | BHBLF10-02G | 10 | 1/4 | 8 | 6 | 22 | 22 | 19 | 7 | 48 | 28 | 28 | 43.5 | 59.5 | 16.5 | 13 |
| BHBLM10-03G | BHBLF10-03G | 10 | 3/8 | 8 | 9 | 22 | 22 | 19 | 7 | 48 | 30 | 29 | 43.5 | 59.5 | 16.5 | 13 |
| BHBLM10-04G | BHBLF10-04G | 10 | 1/2 | 8 | 12 | 24 | 22 | 19 | 7 | 49 | 35 | 33 | 43.5 | 60.5 | 16.5 | 13 |
| BHBLM12-02G | BHBLF12-02G | 12 | 1/4 | 10 | 6 | 24 | 24 | 22 | 7 | 49 | 31 | 30 | 43.5 | 60.5 | 18.5 | 13 |
| BHBLM12-03G | BHBLF12-03G | 12 | 3/8 | 10 | 9 | 24 | 24 | 22 | 7 | 49 | 33 | 30 | 43.5 | 60.5 | 18.5 | 13 |
| BHBLM12-04G | BHBLF12-04G | 12 | 1/2 | 10 | 12 | 24 | 24 | 22 | 7 | 49 | 35 | 33 | 43.5 | 60.5 | 18.5 | 13 |
| BHBLM15-03G | BHBLF15-03G | 15 | 3/8 | 12 | 9 | 27 | 27 | 27 | 7.5 | 57 | 36 | 33 | 49.5 | 69.5 | 22.5 | 15 |
| BHBLM15-04G | BHBLF15-04G | 15 | 1/2 | 12 | 12 | 27 | 27 | 27 | 7.5 | 57 | 37 | 36 | 49.5 | 69.5 | 22.5 | 15 |
| BHBLM16-03G | BHBLF16-03G | 16 | 3/8 | 13 | 9 | 30 | 30 | 30 | 7.5 | 59 | 37 | 34 | 49.5 | 71.5 | 24.5 | 15 |
| BHBLM16-04G | BHBLF16-04G | 16 | 1/2 | 13 | 12 | 30 | 30 | 30 | 7.5 | 59 | 38 | 37 | 49.5 | 71.5 | 24.5 | 15 |
| BHBLM18-04G | BHBLF18-04G | 18 | 1/2 | 14 | 12 | 32 | 32 | 32 | 8 | 63 | 39 | 37 | 51.5 | 75.5 | 26.5 | 15 |
| BHBLM20-06G | BHBLF20-06G | 20 | 3/4 | 16 | 16 | 32 | 32 | 36 | 8 | 65 | 40 | 40 | 51.5 | 77.5 | 28.5 | 15 |
| BHBLM22-04G | BHBLF22-04G | 22 | 1/2 | 18 | 12 | 36 | 36 | 36 | 9 | 65 | 40 | 40 | 51.5 | 77.5 | 30.5 | 15 |
| BHBLM22-06G | BHBLF22-06G | 22 | 3/4 | 18 | 16 | 36 | 36 | 36 | 9 | 65 | 40 | 40 | 51.5 | 77.5 | 30.5 | 15 |
| BHBLM25-06G | BHBLF25-06G | 25 | 3/4 | 20 | 16 | 41 | 41 | 41 | 10 | 68 | 43 | 43 | 52.5 | 81.5 | 35.5 | 15 |
| BHBLM25-08G | BHBLF25-08G | 25 | 1 | 20 | 20 | 41 | 41 | 41 | 10 | 68 | 43 | 43 | 52.5 | 81.5 | 35.5 | 15 |
| BHBLM28-06G | BHBLF28-06G | 28 | 3/4 | 22 | 16 | 46 | 46 | 46 | 10 | 74 | 48 | 48 | 55 | 88 | 38.5 | 15 |
| BHBLM28-08G | BHBLF28-08G | 28 | 1 | 22 | 22 | 46 | 46 | 46 | 10 | 74 | 48 | 48 | 55 | 88 | 38.5 | 15 |
| BHBLM30-06G | BHBLF30-06G | 30 | 3/4 | 25 | 16 | 46 | 46 | 46 | 10 | 74 | 48 | 48 | 55.5 | 88.5 | 40.5 | 15 |
| BHBLM30-08G | BHBLF30-08G | 30 | 1 | 25 | 22 | 46 | 46 | 46 | 10 | 74 | 48 | 48 | 55.5 | 88.5 | 40.5 | 15 |

All dimensions are in millimeters. Dimensions are for reference only, subject to change.

Hydraulic Hose Fittings

■ PART NUMBER DESIGNATIONS

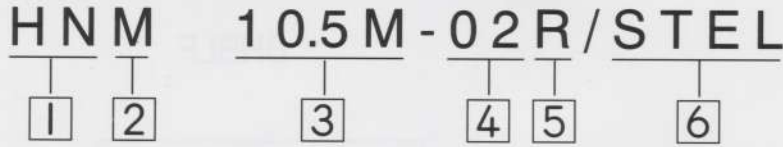

- ① Fitting Symbols : Hose Nipple
- ② End Connection Thread Symbols
M : Male Thread F : Female Thread
- ③ Hose Dimensions Symbols

| | | | | | | |
|-------------|-------|-----|-----|--------|--------|-------|
| Hose Size | 6.5mm | 8mm | 9mm | 10.5mm | 12.7mm | |
| Designation | 6.5M | 8M | 9M | 10.5M | 12.7M | |

- ④ ⑤ Thread Symbols : Refer to 210 Kg/cm²
- ⑥ Material Symbols : STEEL : Carbon Steel
S316 : 316 Stainless steel
BRAS : BRASS

MALE HOSE NIPPLE

HNM

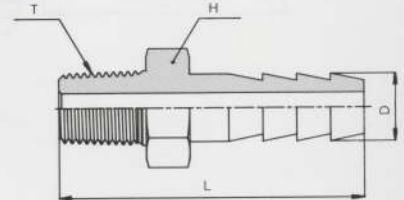

FEMALE HOSE NIPPLE

HNF

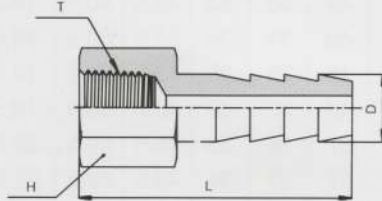

| PART No. | D | T R(PT) | H | L |
|----------------|------|------------|----|----|
| HNF 8M - 02R | 8 | 1/4 | 19 | 39 |
| HNF 8M - 03R | 8 | 3/8 | 22 | 41 |
| HNF 9M - 02R | 9 | 1/4 | 19 | 41 |
| HNF 9M - 03R | 9 | 3/8 | 22 | 41 |
| HNF10.5M - 02R | 10.5 | 1/4 | 19 | 44 |
| HNF10.5M - 03R | 10.5 | 3/8 | 22 | 47 |
| HNF10.5M - 04R | 10.5 | 1/2 | 27 | 51 |
| HNF12.7M - 02R | 12.7 | 1/4 | 19 | 45 |
| HNF12.7M - 03R | 12.7 | 3/8 | 22 | 48 |
| HNF 14M - 04R | 14 | 1/2 | 27 | 52 |

| PART No. | D | T R(PT) | H | L |
|--------------|------|------------|----|-----|
| HNM 6.5M-01R | 6.5 | 1/8 | 12 | 33 |
| HNM 6.5M-02R | 6.5 | 1/4 | 14 | 37 |
| HNM 6.5M-03R | 6.5 | 3/8 | 17 | 39 |
| HNM 8M-01R | 8 | 1/8 | 12 | 36 |
| HNM 8M-02R | 8 | 1/4 | 14 | 40 |
| HNM 8M-03R | 8 | 3/8 | 17 | 42 |
| HNM 9M-02R | 9 | 1/4 | 14 | 42 |
| HNM 9M-03R | 9 | 3/8 | 17 | 43 |
| HNM10.5M-01R | 10.5 | 1/8 | 12 | 40 |
| HNM10.5M-02R | 10.5 | 1/4 | 14 | 45 |
| HNM10.5M-03R | 10.5 | 3/8 | 17 | 46 |
| HNM10.5M-04R | 10.5 | 1/2 | 22 | 51 |
| HNM12.7M-02R | 12.7 | 1/4 | 14 | 46 |
| HNM12.7M-03R | 12.7 | 3/8 | 17 | 48 |
| HNM12.7M-04R | 12.7 | 1/2 | 22 | 52 |
| HNM 14M-02R | 14 | 1/4 | 17 | 47 |
| HNM 14M-03R | 14 | 3/8 | 17 | 48 |
| HNM 14M-04R | 14 | 1/2 | 22 | 52 |
| HNM 16M-04R | 16 | 1/2 | 22 | 52 |
| HNM 16M-06R | 16 | 3/4 | 27 | 54 |
| HNM20.5M-04R | 20.5 | 1/2 | 22 | 59 |
| HNM20.5M-06R | 20.5 | 3/4 | 27 | 61 |
| HNM20.5M-08R | 20.5 | 1 | 36 | 65 |
| HNM 27M-06R | 27 | 3/4 | 30 | 67 |
| HNM 27M-08R | 27 | 1 | 36 | 71 |
| HNM 34M-08R | 34 | 1 | 36 | 86 |
| HNM 34M-10R | 34 | 1-1/4 | 46 | 88 |
| HNM 38M-10R | 38 | 1-1/4 | 46 | 89 |
| HNM 40M-12R | 40 | 1-1/2 | 50 | 92 |
| HNM 52M-16R | 52 | 2 | 65 | 120 |

All dimensions are in millimeters. Dimensions are for reference only, subject to change.

Standard Thread Specification

SAE / MS INTERNAL STRAIGHT THREAD BOSS

O - RINGS FOR SAE BOSSES

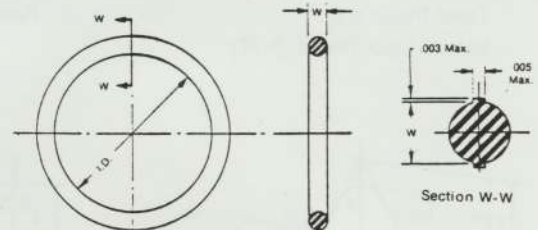
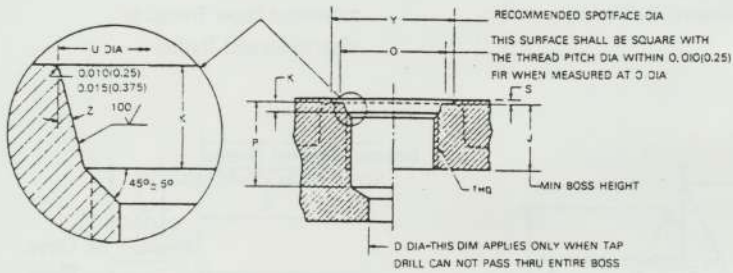

| Port Size | Thread Size | D Min. | J Min. | K $\begin{smallmatrix} +0.4 \\ -0 \end{smallmatrix}$ | O Min. | P Min. | U $\begin{smallmatrix} +0.13 \\ -0 \end{smallmatrix}$ | Y | S Max. | Z ($\pm 1^\circ$) | O-ring Dimensions | |
|-----------|-------------|--------|--------|--|--------|--------|---|----|--------|---------------------|-------------------|------|
| | | | | | | | | | | | ID | W |
| 04 | 7/16-20 | 4.4 | 11.5 | 2.4 | 15 | 14.0 | 12.4 | 21 | 1.6 | 12° | .351 | .072 |
| 05 | 1/2-20 | 6.0 | 11.5 | 2.4 | 16 | 14.0 | 14.0 | 23 | 1.6 | 12° | .414 | .072 |
| 06 | 9/16-18 | 7.5 | 12.7 | 2.5 | 18 | 15.5 | 15.6 | 25 | 1.6 | 12° | .468 | .078 |
| 08 | 3/4-16 | 10.0 | 14.3 | 2.5 | 22 | 17.5 | 20.6 | 30 | 2.4 | 15° | .644 | .087 |
| 10 | 7/8-14 | 12.5 | 16.7 | 2.5 | 26 | 20.5 | 23.9 | 34 | 2.4 | 15° | .755 | .097 |
| 12 | 1-1/16-12 | 16.0 | 19.0 | 3.3 | 32 | 23.0 | 29.2 | 41 | 2.4 | 15° | .924 | .116 |
| 14 | 1-3/16-12 | 18.0 | 19.0 | 3.3 | 35 | 23.0 | 32.3 | 45 | 2.4 | 15° | 1.048 | .116 |
| 16 | 1-5/16-12 | 21.0 | 19.0 | 3.3 | 38 | 23.0 | 35.5 | 49 | 3.2 | 15° | 1.171 | .116 |

INTERNAL STRAIGHT PIPE THREAD BOSS

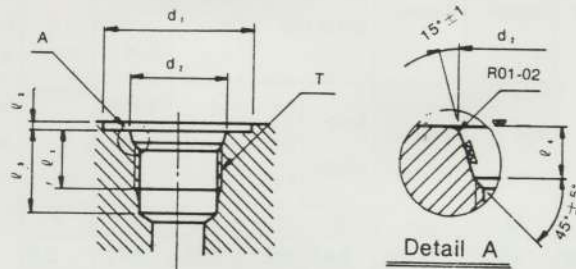

| T G(PF) | d ₁ | d ₂ $\begin{smallmatrix} +0.1 \\ -0 \end{smallmatrix}$ | Min l ₁ | Max l ₂ | Min l ₃ | l ₄ $\begin{smallmatrix} +0.4 \\ -0 \end{smallmatrix}$ | O-Ring Spec. |
|---------|----------------|---|--------------------|--------------------|--------------------|---|--------------|
| 1/8 | 18 | 11.6 | 10 | 1 | 15 | 2 | P 8 |
| 1/4 | 24 | 15.6 | 14 | 1.5 | 20 | 2.5 | P 11 |
| 3/8 | 28 | 18.6 | 14 | 2 | 20 | 2.5 | P 14 |
| 1/2 | 34 | 22.6 | 17 | 2.5 | 25 | 2.5 | P 18 |
| 3/4 | 45 | 29.8 | 19 | 2.5 | 27 | 3.5 | P 24 |
| 1 | 51 | 35.8 | 22 | 2.5 | 31 | 3.5 | P 29 |
| 1-1/4 | 62 | 44.8 | 24 | 2.5 | 33 | 3.5 | P 38 |
| 1-1/2 | 68 | 50.8 | 25 | 2.5 | 34 | 3.5 | P 44 |
| 2 | 76 | 67.2 | 29 | 2.5 | 38 | 3.5 | P 56 |

All dimensions are in millimeters. Dimensions are for reference only, subject to change.

Standard Thread Specification

TAPER PIPE THREADS(JIS B0203 / B0202)

Basic profile of External
Taper Thread and
Internal Taper Thread : R(PT)

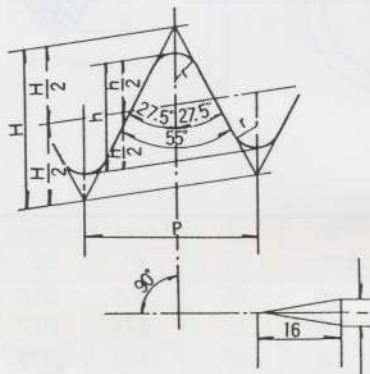

$$P = 25.4 / n$$

$$H = 0.960237 P$$

$$h = 0.640329 P$$

$$r = 0.137278 P$$

Basic profile of Internal
Parallel Thread : G(PF)

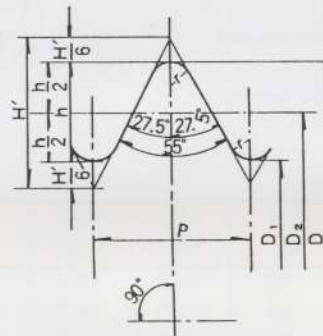

$$P = 25.4 / n$$

$$H' = 0.969491 P$$

$$h = 0.640327 P$$

$$r' = 0.137329 P$$

Fit of External Taper Thread
to Internal Taper Thread or
Internal Parallel Thread

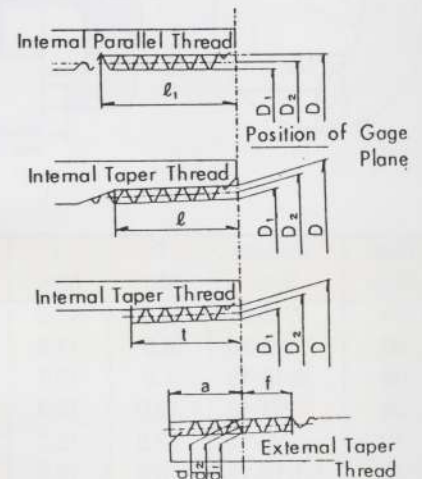

Unit : mm

| Nominal Size | Screw Thread | | | | Basic Diameter | | | Position of Basic Diameter | | | Tol- erances on Basic Di- ameters of In- ter- nal Parallel Thread | Effective Thread Length (Min.) | | | | Nominal Pipe Size (For Reference) | |
|-----------------|---------------------------------------|--------|------------------------|----------|------------------------|-------------------------------------|-------------------------------------|-------------------------------|---------------------------|--------------------------|--|-----------------------------------|---|-----------------------------|---|---|--|
| | Number of Thread per Inch | Pitch | Height of Thread | Rounding | External Thread | | | External Thread | | The End of Pipe | | Fitting Allowance | Internal Thread | | When there is an In- complete Thread | | |
| | | | | | Major Diameter d | Major Diameter d ₂ | Major Diameter d ₁ | From the End of Pipe | Internal Thread | | | | When there is an In- complete Thread | | | | |
| | | | | | Major Diameter | Pitch Diameter | Minor Diameter | Basic Length | Tol- erance Axially | | | | Tol- erance Axially | Internal Taper Thread | | Internal Parallel Thread | Internal Taper and Parallel Thread |
| | n | p | h | r | D | D ₂ | D ₂ | a | ±b | ±c | | ± | f | l | l ₁ | t | |
| R(PT) 1/8 | 28 | 0.9071 | 0.581 | 0.12 | 9.728 | 9.147 | 8.566 | 3.97 | 0.91 | 1.13 | 0.071 | 2.5 | 6.2 | 7.4 | 4.4 | 10.5 | 2.0 |
| R(PT) 1/4 | 19 | 1.3368 | 0.856 | 0.18 | 13.157 | 12.301 | 11.445 | 6.01 | 1.34 | 1.67 | 0.104 | 3.7 | 9.4 | 11.0 | 6.7 | 13.8 | 2.3 |
| R(PT) 3/8 | 19 | 1.3368 | 0.856 | 0.18 | 16.662 | 15.806 | 14.950 | 6.35 | 1.34 | 1.67 | 0.104 | 3.7 | 9.7 | 11.4 | 7.0 | 17.3 | 2.3 |
| R(PT) 1/2 | 14 | 1.8143 | 1.162 | 0.25 | 20.955 | 19.793 | 18.631 | 8.16 | 1.81 | 2.27 | 0.142 | 5.0 | 12.7 | 15.0 | 9.1 | 21.7 | 2.8 |
| R(PT) 3/4 | 14 | 1.8143 | 1.162 | 0.25 | 26.441 | 25.279 | 24.117 | 9.53 | 1.81 | 2.27 | 0.142 | 5.0 | 14.1 | 16.3 | 10.2 | 27.2 | 2.8 |
| R(PT) 1 | 11 | 2.3091 | 1.479 | 0.32 | 33.249 | 31.770 | 30.291 | 10.39 | 2.31 | 2.89 | 0.181 | 6.4 | 16.2 | 19.1 | 11.6 | 34.0 | 3.2 |
| R(PT) 1 1/4 | 11 | 2.3091 | 1.479 | 0.32 | 41.910 | 40.431 | 38.952 | 12.70 | 2.31 | 2.89 | 0.181 | 6.4 | 18.5 | 21.4 | 13.4 | 42.7 | 3.5 |
| R(PT) 1 1/2 | 11 | 2.3091 | 1.479 | 0.32 | 47.803 | 46.324 | 44.845 | 12.70 | 2.31 | 2.89 | 0.181 | 6.4 | 18.5 | 21.4 | 13.4 | 48.6 | 3.5 |
| R(PT) 2 | 11 | 2.3091 | 1.479 | 0.32 | 59.614 | 58.135 | 56.656 | 15.88 | 2.31 | 2.89 | 0.181 | 7.5 | 22.8 | 25.7 | 16.9 | 60.5 | 3.8 |
| R(PT) 2 1/2 | 11 | 2.3091 | 1.479 | 0.32 | 75.184 | 73.705 | 72.226 | 17.46 | 3.46 | 3.46 | 0.216 | 9.2 | 26.7 | 30.1 | 18.6 | 76.3 | 4.2 |
| R(PT) 3 | 11 | 2.3091 | 1.479 | 0.32 | 87.884 | 86.405 | 84.926 | 20.64 | 3.46 | 3.46 | 0.216 | 9.2 | 29.8 | 33.3 | 21.1 | 89.1 | 4.2 |
| R(PT) 3 1/2 | 11 | 2.3091 | 1.479 | 0.32 | 100.330 | 98.851 | 97.372 | 22.23 | 3.46 | 3.46 | 0.216 | 9.2 | 31.4 | 34.9 | 22.4 | 101.6 | 4.2 |
| R(PT) 4 | 11 | 2.3091 | 1.479 | 0.32 | 113.030 | 111.551 | 110.072 | 25.40 | 3.46 | 3.46 | 0.216 | 10.4 | 35.8 | 39.3 | 25.9 | 114.3 | 4.5 |
| R(PT) 5 | 11 | 2.3091 | 1.479 | 0.32 | 138.430 | 136.951 | 135.472 | 28.58 | 3.46 | 3.46 | 0.216 | 11.5 | 40.1 | 43.5 | 29.3 | 139.8 | 4.5 |
| R(PT) 6 | 11 | 2.3091 | 1.479 | 0.32 | 163.830 | 162.351 | 160.872 | 28.58 | 3.46 | 3.46 | 0.216 | 11.5 | 40.1 | 43.5 | 29.4 | 165.2 | 5.0 |

Standard Thread Specification

AMERICAN NATIONAL STANDARD TAPER PIPE THREADS : NPT(ANSI : B1.20.1)

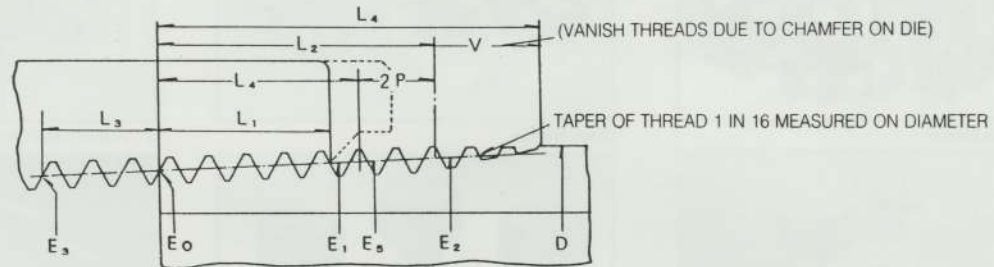

Unit : Inch

| Nominal Pipe Size | Wrench Make - up Length for External Thread $L_2 - L_1$ | Wrench Make - up Length for Internal Thread | | Vanish Thread, V (3.47 Thds) | Overall Length External Thread L_4 | Nominal Perfect External Threads | | Height of Thread h | Basic Minor Diam. at Small End of Pipe K_0 |
|-------------------|---|---|-----------|--------------------------------|--------------------------------------|----------------------------------|-----------|----------------------|--|
| | | Length L_3 | Dia E_3 | | | Length L_5 | Dia E_5 | | |
| 1/16 | 0.1011 | 0.1111 | 0.26424 | 0.1285 | 0.3896 | 0.1870 | 0.28287 | 0.02963 | 0.2416 |
| 1/8 | 0.1024 | 0.1111 | 0.35656 | 0.1285 | 0.3924 | 0.1898 | 0.37537 | 0.02963 | 0.3339 |
| 1/4 | 0.1740 | 0.1667 | 0.46697 | 0.1928 | 0.5946 | 0.2907 | 0.49556 | 0.04444 | 0.4329 |
| 3/8 | 0.1678 | 0.1667 | 0.60160 | 0.1928 | 0.6006 | 0.2967 | 0.63056 | 0.04444 | 0.5676 |
| 1/2 | 0.2137 | 0.2143 | 0.74504 | 0.2478 | 0.7815 | 0.3909 | 0.78286 | 0.05714 | 0.7013 |
| 3/4 | 0.2067 | 0.2143 | 0.95429 | 0.2478 | 0.7935 | 0.4029 | 0.99286 | 0.05714 | 0.9105 |
| 1 | 0.2828 | 0.2609 | 1.19733 | 0.3017 | 0.9845 | 0.5089 | 1.24543 | 0.06957 | 1.1441 |
| 1 1/4 | 0.2868 | 0.2609 | 1.54083 | 0.3017 | 1.0085 | 0.5329 | 1.59043 | 0.06957 | 1.4876 |
| 1 1/2 | 0.3035 | 0.2609 | 1.77978 | 0.3017 | 1.0252 | 0.5496 | 1.83043 | 0.06957 | 1.7265 |
| 2 | 0.3205 | 0.2609 | 2.25272 | 0.3017 | 1.0582 | 0.5826 | 2.30543 | 0.06957 | 2.1995 |
| 2 1/2 | 0.4555 | 0.2500 | 2.70391 | 0.4337 | 1.5712 | 0.8875 | 2.77500 | 0.10000 | 2.6195 |
| 3 | 0.4340 | 0.2500 | 3.32500 | 0.4337 | 1.6337 | 0.9500 | 3.40000 | 0.10000 | 3.2406 |
| 3 1/2 | 0.4290 | 0.2500 | 3.82188 | 0.4337 | 1.6837 | 1.0000 | 3.90000 | 0.10000 | 3.7375 |
| 4 | 0.4560 | 0.2500 | 4.31875 | 0.4337 | 1.7337 | 1.0500 | 4.40000 | 0.10000 | 4.2344 |
| 5 | 0.4693 | 0.2500 | 5.37511 | 0.4337 | 1.8400 | 1.1563 | 5.46300 | 0.10000 | 5.2907 |
| 6 | 0.5545 | 0.2500 | 6.43047 | 0.4337 | 1.9462 | 1.2625 | 6.52500 | 0.10000 | 6.3461 |

| Nominal | Outside Diam. of Pipe D | Threads per Inch n | Pitch of Thread P | Pitch Diameter at Beginning of External Thread E_0 | Handtight Engagement | | Effective Thread External | |
|---------|---------------------------|----------------------|---------------------|--|----------------------|------------|---------------------------|------------|
| | | | | | Length L_1 | Diam E_1 | Length L_2 | Diam E_2 |
| 1/16 | 0.3125 | 27 | 0.03704 | 0.27118 | 0.160 | 0.28118 | 0.2611 | 0.28750 |
| 1/8 | 0.405 | 27 | 0.03704 | 0.36351 | 0.1615 | 0.37360 | 0.2639 | 0.38000 |
| 1/4 | 0.540 | 18 | 0.05556 | 0.47739 | 0.2278 | 0.49163 | 0.4018 | 0.50250 |
| 3/8 | 0.675 | 18 | 0.05556 | 0.61201 | 0.240 | 0.62701 | 0.4078 | 0.63750 |
| 1/2 | 0.840 | 14 | 0.07143 | 0.75843 | 0.320 | 0.77843 | 0.5337 | 0.79179 |
| 3/4 | 1.050 | 14 | 0.07143 | 0.96768 | 0.339 | 0.98887 | 0.5457 | 1.00179 |
| 1 | 1.315 | 11 1/2 | 0.08696 | 1.21363 | 0.400 | 1.23863 | 0.6828 | 1.25630 |
| 1 1/4 | 1.660 | 11 1/2 | 0.08696 | 1.55713 | 0.420 | 1.58338 | 0.7068 | 1.60130 |
| 1 1/2 | 1.900 | 11 1/2 | 0.08696 | 1.79609 | 0.420 | 1.82234 | 0.7235 | 1.84130 |
| 2 | 2.375 | 11 1/2 | 0.08696 | 2.26902 | 0.436 | 2.29627 | 0.7565 | 2.31630 |
| 2 1/2 | 2.875 | 8 | 0.12500 | 2.71953 | 0.682 | 2.76216 | 1.1375 | 2.79062 |
| 3 | 3.500 | 8 | 0.12500 | 3.34062 | 0.766 | 3.38850 | 1.2000 | 3.41562 |
| 3 1/2 | 4.000 | 8 | 0.12500 | 3.83750 | 0.821 | 3.88881 | 1.2500 | 3.91562 |
| 4 | 4.500 | 8 | 0.12500 | 4.33438 | 0.844 | 4.38712 | 1.3000 | 4.41562 |
| 5 | 5.563 | 8 | 0.12500 | 5.39073 | 0.937 | 5.44929 | 1.4063 | 5.47862 |
| 6 | 6.625 | 8 | 0.12500 | 6.44609 | 0.958 | 6.50597 | 1.5125 | 6.54062 |